

RES-409

Operating instructions

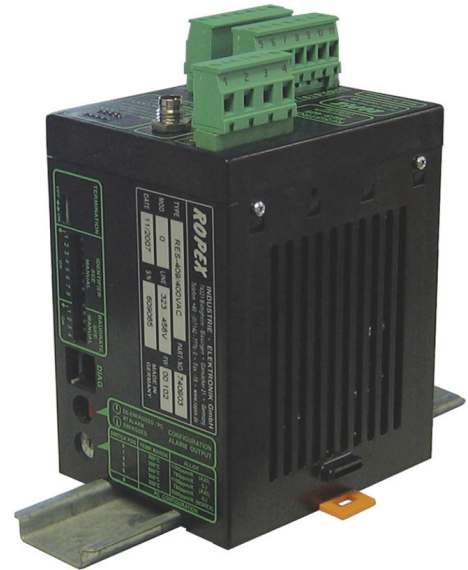

Important features

- Microprocessor technology
- Complete control via CAN-Bus interface (CAN 2.0A according ISO 11898)
Remark: CANopen is not supported
- Automatic zero calibration (AUTOCAL)
- Automatic optimization (AUTOTUNE)
- Automatic configuration of the secondary voltage and current ranges (AUTORANGE, as of February 2007)
- Automatic phase angle compensation (AUTOCOMP, as of February 2007)
- Automatic frequency adjustment
- Large current and voltage range
- 0...10VDC analog output for ACTUAL temperature
- Additional 24VDC control signals for START 0 (Set 0) and START 1 (Set 1) (as of February 2007)
- Alarm function with fault diagnosis
- Heatsealing band alloy and temperature range selectable
- Booster connection as standard (as of February 2007)

Contents

1	General information	3	10	Controller functions	30
1.1	Copyright	3	10.1	Indicators and controls	30
1.2	Intended use	3	10.2	CAN protocol	31
1.3	Heatsealing band	3	10.3	Receiving CAN messages	32
1.4	Impulse transformer	4	10.4	Sending CAN messages	38
1.5	Current transformer PEX-W4/-W5	4	10.5	Temperature meter (actual value output) 42	
1.6	Line filter	4	10.6	Hold mode	43
1.7	Maintenance	4	10.7	Measuring impulse length (as of February 2007)	45
1.8	Transportation	4	10.8	Automatic phase compensation (AUTO- COMP, as of February 2007)	45
1.9	Disposal	5	10.9	Temperature monitoring / "temperature OK" bit (as of February 2007)	47
2	Application	7	10.10	Temperature diagnosis (as of February 2007)	48
3	Principle of operation	7	10.11	Heatup timeout (as of February 2007)	49
4	Description of the controller	8	10.12	Diagnostic interface / visualization soft- ware (as of February 2007)	50
5	Accessories and modifications	9	10.13	Booster connection	50
5.1	Accessories	9	10.14	Undervoltage detection (as of February 2007)	51
5.2	Modifications (MODs)	10	10.15	System monitoring / fault output	51
6	Technical data	11	10.16	Error messages	52
7	Dimensions	14	10.17	Fault areas and causes	57
8	Montage und Installation	14	11	Factory settings	58
8.1	Installation procedure	14	12	Maintenance	59
8.2	Installation steps	16	13	How to order	60
8.3	Power supply	17	14	Index	62
8.4	Line filter	18			
8.5	Current transformer PEX-W4/-W5	18			
8.6	Wiring diagram (standard)	20			
8.7	Wiring diagram with booster connection (MOD 26)	21			
9	Startup and operation	22			
9.1	View of the controller	22			
9.2	Controller configuration	22			
9.3	Heatsealing band	27			
9.4	Startup procedure	28			

1 General information

This RESISTRON® temperature controller is manufactured according to EN 61010-1. In the course of its manufacture it passed through quality assurance, whereby it was subjected to extensive inspections and tests. As a result of this, the product left our factory in perfect condition.

Please carefully read through the operating manual before using the RESISTRON® temperature controller. Keep the operating manual for later reference and make sure that information and functions important for the user are available.

The recommendations and warning notes contained in these operating instructions must be complied with, in order to guarantee safe operation.

The device can be operated within the limits indicated in the "Technical Data" without impairing its operational safety. Installation and maintenance may only be performed by technically trained, skilled persons who are familiar with the associated risks and warranty provisions.

1.1 Copyright

All contents, in particular texts, photographs and graphics, are protected by copyright. All rights, including to replication, publication, editing and translation, are reserved.

1.2 Intended use

RESISTRON® temperature controllers may only be used for heating and temperature control of heatsealing bands which are expressly approved for them, and providing the regulations, notes and warnings contained in these instructions are observed.

In case of non-observance or use contrary to the intended purpose, there is a risk that safety will be impaired or that the heatsealing band, electrical wiring, transformer etc. will overheat. This is the personal responsibility of the user.

1.3 Heatsealing band

The use of suitable heatsealing bands is a basic prerequisite for reliable and safe operation of the system.

The resistance of the heatsealing band which is used must have a positive minimum temperature coefficient in order to guarantee trouble-free operation of the RESISTRON® temperature controller.

The temperature coefficient must be specified as follows:

$$TCR = 10 \times 10^{-4} \text{K}^{-1} \text{ or } \text{K}^{-1} \text{ or } \text{ppm/K}$$

e.g. Alloy A20: TCR = 1100 ppm/K
LEX3500: TCR = 3500 ppm/K
Vacodil: TCR = 1100 ppm/K

The RESISTRON® temperature controller must be set and coded according to the temperature coefficient of the heatsealing band.

The temperature coefficient must be taken from the ROPEX application report and must be set accordingly.

 **The use of incorrect alloys with a too low temperature coefficient and incorrect coding of the RESISTRON® temperature controller leads to uncontrolled heating of the heatsealing band, which will ultimately burn out!**

The original heatsealing bands must be clearly identified by means of suitable markings as well as the connector geometry, length, or other means to ensure that replacement bands are identical.

1.4 Impulse transformer

A suitable impulse transformer is necessary in order to guarantee trouble-free operation of the control loop. This transformer must be designed according to EN 61558 or UL 5058 (isolating transformer with reinforced insulation) and have a one section bobbin. When the impulse transformer is installed, suitable touch protection must be provided in accordance with the national installation regulations for electrical equipment. In addition to this, water, cleaning solutions and conductive fluids must be prevented from seeping into the transformer.

Incorrect installation of the impulse transformer impairs electrical safety.

1.5 Current transformer PEX-W4/-W5

The current transformer supplied with the RESISTRON[®] temperature controller is an integral part of the control system.

Only the original ROPEX PEX-W4 or PEX-W5 current transformer may be used. Other transformers may cause the equipment to malfunction.

The current transformer may only be operated if it is correctly connected to the RESISTRON[®] temperature controller (see section "Startup and operation"). The relevant safety instructions contained in section "Power supply", must be observed. External monitoring modules can be used in order to additionally increase operating safety. They are not included in the scope of supply of the standard control system and are described in a separate document.

1.6 Line filter

ROPEX provides line filters in different power classes. The ROPEX application report lists the suitable line filter which can be ordered accordingly.

The use of an original ROPEX line filter is mandatory in order to comply with the directives mentioned in section "DECLARATION OF CONFORMITY" on page 6. This device must be installed and connected according to the instructions contained in section "Power supply" as well as the separate documentation enclosed with the line filter.

1.7 Maintenance

The controller requires no special maintenance. Regular inspection and / or tightening of the terminals – including the terminals for the winding connections on the impulse transformer – is recommended. Dust deposits on the controller can be removed with dry compressed air.



Dust deposits and dirt from liquids result in a loss of function. Accordingly, installation in a switch cabinet or terminal cabinet with IP54 is recommended.

1.8 Transportation

Store and transport the device in its original carton.

After transport, perform a visual inspection for possible damage.

1.9 Disposal



This device is subject to Directive 2012/19/EU concerning the reduction of the increasing amount of waste electrical and electronic equipment and the disposal of such waste in an environmentally sound way.

To guarantee proper disposal and / or the recover of reusable material, please take the device to a designated municipal collection point and observe local regulations.

 Careless, uncontrolled disposal can cause damage to the environment and human health. By ensuring that your product is disposed of or recycled in a responsible way, you can help protect the environment and human health.



This device must not be disposed of as residual waste!

DECLARATION OF CONFORMITY

We hereby declare that the following device has been developed and manufactured in conformance with the directives cited below:

Designation: RESISTRON temperature controller with accessories
Type: RES-409 with line filter and current transformer
Operating principle: Impulse sealing of films and plastics

Compliant with following standards and directives:

EN 61010-1 Safety requirements for electrical equipment, control, and laboratory use
2014/35/EU low voltage directive
2014/30/EU electromagnetic compatibility directive
2011/65/EU RoHS directive

Note:

This declaration of conformity certifies that the device/electronic itself complies with the above-mentioned directives. The CE mark on the device/electronic does not relieve the machinery manufacturer of his duty to verify the conformity of the completely installed, wired and operationally ready system in the machine with the EMC directive.

Comments:

RESISTRON/CIRUS temperature controllers are not independently operable devices. They are used by the machinery manufacturer to form a sealing system by adding EMC-relevant components such as filters, transformers, heatsealing bands and wiring. The final configuration may vary significantly in terms of performance and physical dimensions. All information provided by us in connection with the line filter is merely intended as a guide and is based on a typical measuring setup. It serves to demonstrate that compliance with the EMC directive can be achieved by using a line filter that is suitable for the overall system. The line filter and current transformer must, however, be determined on the basis of the respective application. We also wish to point out that the transformer which is used must be designed in accordance with VDE 0551/EN 61558 or UL 5058 for safety reasons.

July 12, 2020



J. Kühner (CEO)

ROPEX Industrie-Elektronik GmbH
Adolf-Heim-Str. 4
74321 Bietigheim-Bissingen (Germany)

2 Application

This RESISTRON® temperature controller is an integral part of the "Series 400", the outstanding feature of which is its microprocessor technology. All RESISTRON temperature controllers are used to control the temperature of heating elements (heatsealing bands, beaded bands, cutting wires, heatsealing blades, solder elements etc.), as required in a variety of heatsealing processes.

The controller is most commonly used for impulse-heatsealing PE films in:

- Vertical and horizontal f/f/s machines
- Pouch, filling and sealing machines
- Film wrapping machines
- Pouch-making machines
- Group packaging machines
- etc.

The use of RESISTRON temperature controllers results in:

- Repeatable quality of the heatseals under any conditions
- Increased machine capacity
- Extended life of the heatsealing bands and teflon coatings
- Simple operation and control of the sealing process

3 Principle of operation

The resistance of the heatsealing band, which is temperature-sensitive, is monitored 50x per second (60x at 60Hz) by measuring the current and voltage. The temperature calculated with the help of these measurements is displayed and compared with the set point.

The primary voltage of the impulse transformer is adjusted by phase-angle control, if the measured values deviate from the set point. The resulting change in the current through the heatsealing band leads to a change in the band temperature and thus also its resistance. This change is measured and evaluated by the RESISTRON® temperature controller.

The control loop is closed: ACTUAL temperature = SET temperature. Even minute thermal loads on the heatsealing band are detected and can be corrected quickly and precisely.

A highly high response thermo-electric control loop is formed which is highly accurate because purely electrical variables are measured at a high sampling rate. A high secondary current can be controlled because power is controlled on the primary side of the transformer. This allows optimum adaptation to the load and to the required dynamic range despite the exceptionally compact dimensions of the controller.

PLEASE NOTE!

RESISTRON temperature controllers play a significant role in enhancing the performance of modern machines. However, the full benefit can only be obtained from the advanced technology offered by this control system if all

the system components, in other words the heatsealing band, the impulse transformer, the wiring, the timing signals and the controller itself, are carefully compatible and interrelated.

We will be pleased to contribute our many years of experience towards optimizing *your* heatsealing system.

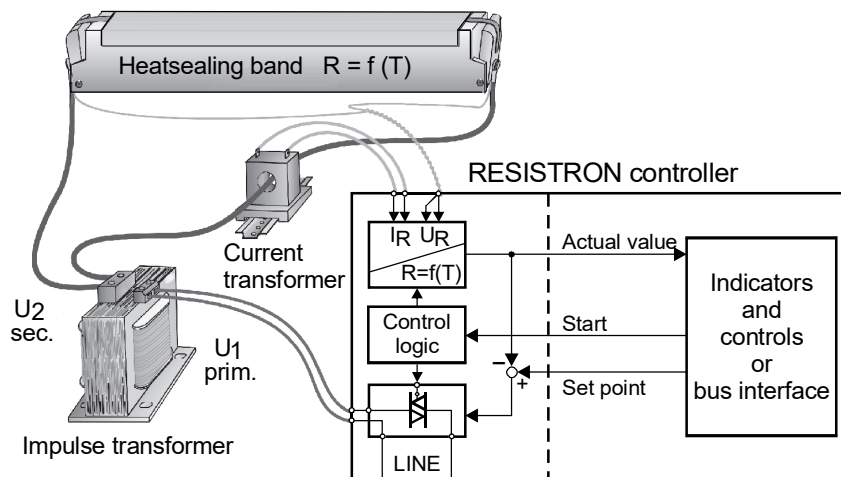

4 Description of the controller

The microprocessor technology endows the RESISTRON[®] temperature controller RES-409 with previously unattainable capabilities:

- Very simple operation thanks to AUTOCAL, the automatic zero calibration function.
- Good dynamic response of the control system thanks to AUTOTUNE, which adapts automatically to the controlled system.
- High precision thanks to further improved control accuracy and linearization of the heatsealing band characteristic.
- High flexibility: The AUTORANGE function (as of February 2006) covers a secondary voltage range from 0.4V to 120V and a current range from 30A to 500A.
- Automatic adjustment to the line frequency in the range from 47Hz to 63Hz.
- Increased protection against dangerous conditions, such as overheating of the heatsealing band.

The RESISTRON[®] temperature controller RES-409 is equipped with a CAN-Bus interface type CAN 2.0A according ISO 11898 (Remark: CANopen is not supported). This interface can be used to control all the controller functions and interrogate controller information.

The ACTUAL temperature of the heatsealing band is supplied to the CAN-Bus interface and to an analog 0 to 10VDC output. The real heatsealing band temperature can thus be displayed on an external temperature meter (e.g. ATR-x).

The RES-409 features an integrated fault diagnosis function, which tests both the external system (heatsealing band, wiring etc.) and the internal electronics and outputs a selective error message in case of a fault.

To increase operational safety and interference immunity, all CAN-Bus signals are electrically isolated from the controller and the heating circuit.

Either coding switches on the temperature controller itself or the CAN-Bus interface can be used to adapt to different heatsealing band alloys (Alloy A20, LEX3500 etc.) and set to the required temperature range (0...300 °C, 0...500 °C etc.).





The compact design of the RESISTRON[®] temperature controller RES-409 and the plug-in connections make this controller easy to install.



5 Accessories and modifications

A wide range of compatible accessories and peripheral devices are available for the RESISTRON[®] temperature controller RES-409. They allow it to be optimally adapted to your specific heatsealing application and to your plant's design and operating philosophy.

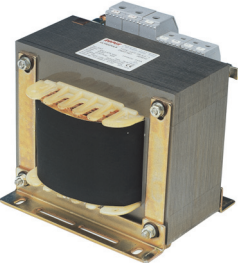
5.1 Accessories

The products described below are only a few of the wide range of accessories available for RESISTRON temperature controllers (↪ "Accessories" leaflet).

	<p>Analog temperature meter ATR-x For front panel mounting or mounting on a top hat rail (DIN TS35 rail). Analog indication of the ACTUAL temperature of the heatsealing band in °C. The meter damping of the unit is optimized for the abrupt temperature changes that occur in impulse mode.</p>
	<p>Digital temperature meter DTR-x For front panel mounting or mounting on a top hat rail (DIN TS35 rail). Digital indication of the ACTUAL temperature of the heatsealing band in °C, with HOLD function.</p>
	<p>Line filter LF-xx480 Essential in order to ensure CE conformity. Optimized for the RESISTRON[®] temperature controller.</p>
	<p>Impulse transformer ITR-x Designed according to VDE 0570/EN 61558 with a one section bobbin. Optimized for impulse operation with RESISTRON temperature controllers. Specified according to the heatsealing application (↪ ROPEX Application Report).</p>
	<p>Communication interface CI-USB-1 Interface for connecting a RESISTRON temperature controller with diagnostic interface (DIAG) to the PC (USB port). Associated PC visualization software for displaying setting and configuration data, and for recording SET and ACTUAL temperatures in real time.</p>

	<p>Booster B-xxx400 External switching amplifier, necessary for high primary currents (continuous current > 5A, pulsed current > 25A).</p>
	<p>Monitoring current transformer For detecting frame short-circuits on the heatsealing band. Used as an alternative to the standard PEX-W2/-W3 current transformer.</p>
	<p>Measurement cable UML-1 twisted measurement cable for the U_R-voltage measurement. Trailing cable, halogene und silicone free.</p>

5.2 Modifications (MODs)

Owing to its universal design, the RESISTRON[®] temperature controller RES-409 is suitable for a very wide range of heatsealing applications.

Two modifications (MOD) are available for the RESISTRON[®] temperature controller RES-409 for implementing special applications.

MOD 01

Amplifier for low secondary voltages ($U_R = 0.25 \dots 16VAC$). This modification is necessary, for example, for very short or low-resistance heatsealing bands.

MOD 26 (up to January 2007)

Additional terminal for connecting an external switching amplifier (booster). This modification is necessary for high primary currents (continuous current > 5A, pulsed current > 25A).



This modification is supplied as standard with all controllers manufactured as of February 2007
(☞ section 10.13 "Booster connection" on page 50)

6 Technical data

Type of construction	Housing for installation in the electrical cabinet Snaps onto a standard top hat rail (DIN TS35 rail, 35 mm) acc. to DIN EN 50022 Dimensions: 90 x 75mm; height: 135 mm (incl. terminals)
Line voltage	<p><u>All controllers manufactured as of February 2007:</u> 115VAC version: 110VAC -15%...120VAC +10% (equivalent to 94...132VAC) 230VAC version: 220VAC -15%...240VAC +10% (equivalent to 187...264VAC) 400VAC version: 380VAC -15%...415VAC +10% (equivalent to 323...456VAC)</p> <p><u>All controllers manufactured as of January 2004 up to January 2007:</u> 115VAC version: 115VAC -15%...120VAC +10% (equivalent to 98...132VAC) 230VAC version: 230VAC -15%...240VAC +10% (equivalent to 196...264VAC) 400VAC version: 400VAC -15%...415VAC +10% (equivalent to 340...456VAC)</p> <p><u>All controllers manufactured up to December 2003:</u> 115VAC, 230VAC or 400VAC, tolerance: +10% / -15%</p> <p>depending on version selected (↪ section 13 "How to order" on page 60)</p>
Line frequency	47...63Hz, automatic adjustment to frequencies in this range
CAN-Bus interface	CAN Bus-interface type CAN 2.0A according ISO 11898 (CANopen is not supported) 2 x 3-pole M8 circular connector acc. to IEC 947-5-2 <p><u>All controllers manufactured as of February 2007:</u> Baud rates: 20kBaud; 50kBaud; 100kBaud, 125kBaud; 205kBaud; 250kBaud; 500kBaud; 800kBaud; 1MBaud</p> <p><u>All controllers manufactured up to January 2007:</u> Baud rates: 10kBaud; 50kBaud; 125kBaud; 205kBaud; 250kBaud; 500kBaud; 800kBaud; 1MBaud</p>

Heatsealing band type and temperature range	<p><u>All controllers manufactured as of February 2007:</u> The temperature range and temperature coefficient settings can also be specified in the ROPEX visualization software (↪ section 10.12 "Diagnostic interface / visualization software (as of February 2007)" on page 50) in addition to using the rotary coding switch (see below) or the CAN interface: Temperature range: 200°C, 300°C, 400°C or 500°C Temperature coefficient: 400...4000ppm (variable setting range)</p> <p>Five different ranges can be set with the rotary coding switch: Temperature coefficient 1100ppm, 0...300°C (e.g. Alloy A20) Temperature coefficient 780ppm, 0...300°C (e.g. Alloy L) Temperature coefficient 1100ppm, 0...500°C (e.g. Alloy A20) Temperature coefficient 780ppm, 0...500°C (e.g. Alloy L) Temperature coefficient 3500ppm, 0...300°C (e.g. LEX3500)</p> <p>Various ranges can be selected via the CAN interface: Temperature coefficient 1100ppm (e.g. Alloy A20) 0...200°C, 0...300°C, 0...400°C, 0...500°C Temperature coefficient 780ppm (e.g. Alloy L) 0...200°C, 0...300°C, 0...400°C, 0...500°C Temperature coefficient 3500ppm (e.g. LEX3500) 0...200°C, 0...300°C, 0...400°C, 0...500°C</p> <p> All controllers manufactured as of February 2007: The settings with the rotary coding switch are considered to be the factory setting. This corresponds to CAN message address 8, value 10 (dec) (↪ section 10.3 "Receiving CAN messages" on page 32).</p> <p><u>All controllers manufactured up to January 2007:</u> Six different ranges can be set via the CAN interface: Temperature coefficient 1100ppm, 0...200°C (e.g. Alloy A20) Temperature coefficient 1100ppm, 0...300°C (e.g. Alloy A20) Temperature coefficient 1100ppm, 0...400°C (e.g. Alloy A20) Temperature coefficient 1100ppm, 0...500°C (e.g. Alloy A20) Temperature coefficient 3500ppm, 0...200°C (e.g. LEX3500) Temperature coefficient 3500ppm, 0...300°C (e.g. LEX3500)</p>
Analog output (actual value) Terminals 17+18	0...10V DC, I _{max} = 5mA Equivalent to 0...300°C or 0...500°C Accuracy: ±1% add. 50mV
Digital logic levels Terminals 5, 7 (As of February 2007)	LOW (0V): 0...2VDC, electrically isolated HIGH (24VDC): 12...30VDC (max. current input 6mA) Reverse polarity-protected
Alarm relay Terminals 12, 13, 14	U _{max} = 30V (DC/AC), I _{max} = 0.2A, changeover contact, potential-free
Maximum load (primary current of impulse transformer)	I _{max} = 5A (duty cycle = 100%) I _{max} = 25A (duty cycle = 20%)
Power dissipation	max. 20W

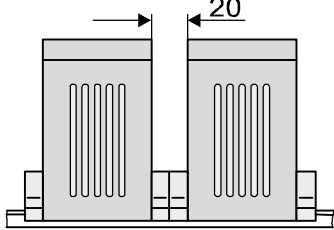
Ambient temperature	+5...+45°C	
Degree of protection	IP20	
Installation	<p>If several controllers are installed on one top hat rail (DIN TS35 rail), a clearance of at least 20 mm should be allowed between them.</p> <p>The moving clip required for fastening must be facing down for mounting on a horizontal top hat rail.</p> <p>End holders to mechanical fix the controller must be fitted at both ends for mounting on a vertical top hat rail.</p>	
Weight	Approx. 0.7kg (incl. connector plug-in parts)	
Housing material	Plastic, polycarbonate, UL-94-V0	
Connecting cables Type / cross-sections	Rigid or flexible; 0.2...2.5mm ² (AWG 24...12) Plug-in connectors <p>⚠ If ferrules are used, they must be crimped in accordance with DIN 46228 and IEC/EN 60947-1. This is essential for proper electrical contact in the terminals.</p>	

7 Dimensions

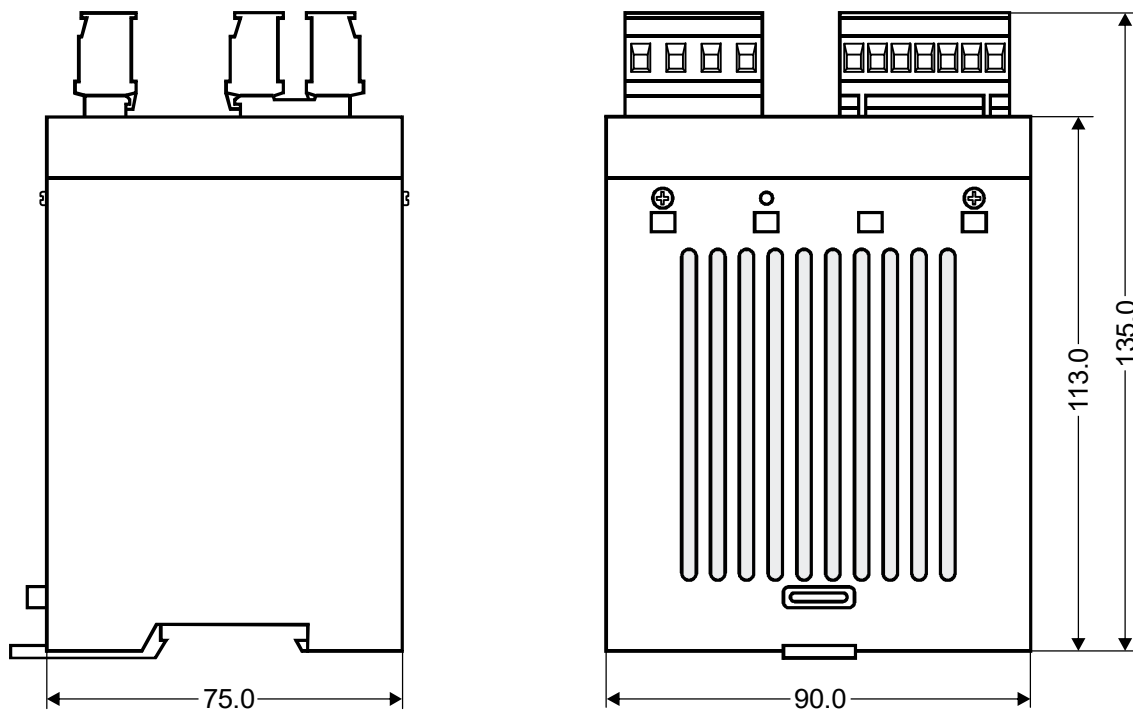

8 Montage und Installation

↳ See also section 1 "General information" on page 3.



Installation and startup may only be performed by technically trained, skilled persons who are familiar with the associated risks and warranty provisions.

8.1 Installation procedure

Proceed as follows to install the RES-409 RESISTRON[®] temperature controller:

1. Switch off the line voltage and verify that all circuits are deenergized.
2. The supply voltage specified on the nameplate of the RESISTRON[®] temperature controller must be identical to the line voltage that is present in the plant or machine. The line frequency is automatically detected by the temperature controller in the range from 47Hz to 63Hz.
3. Install the RESISTRON[®] temperature controller on a standard top hat rail (DIN TS35 rail according to DIN EN 50022) in the electrical cabinet. If several controllers are installed on one top hat rail, the minimum clearance specified in section 6 "Technical data" on page 11 must be allowed between them.

4. Wire the system in accordance with the instructions in section 8.3 "Power supply" on page 17, section 8.6 "Wiring diagram (standard)" on page 20 and the ROPEX Application Report. The information provided in section 8.2 "Installation steps" on page 16 must be additionally heeded.
5. Connect the RESISTRON[®] temperature controller to the CAN master using a cable according to IEC 947-5-2.



Check the tightness of all system connections, including the terminals for the impulse transformer winding wires.

6. Make sure that the wiring conforms to all relevant national and international installation regulations.

8.2 Installation steps

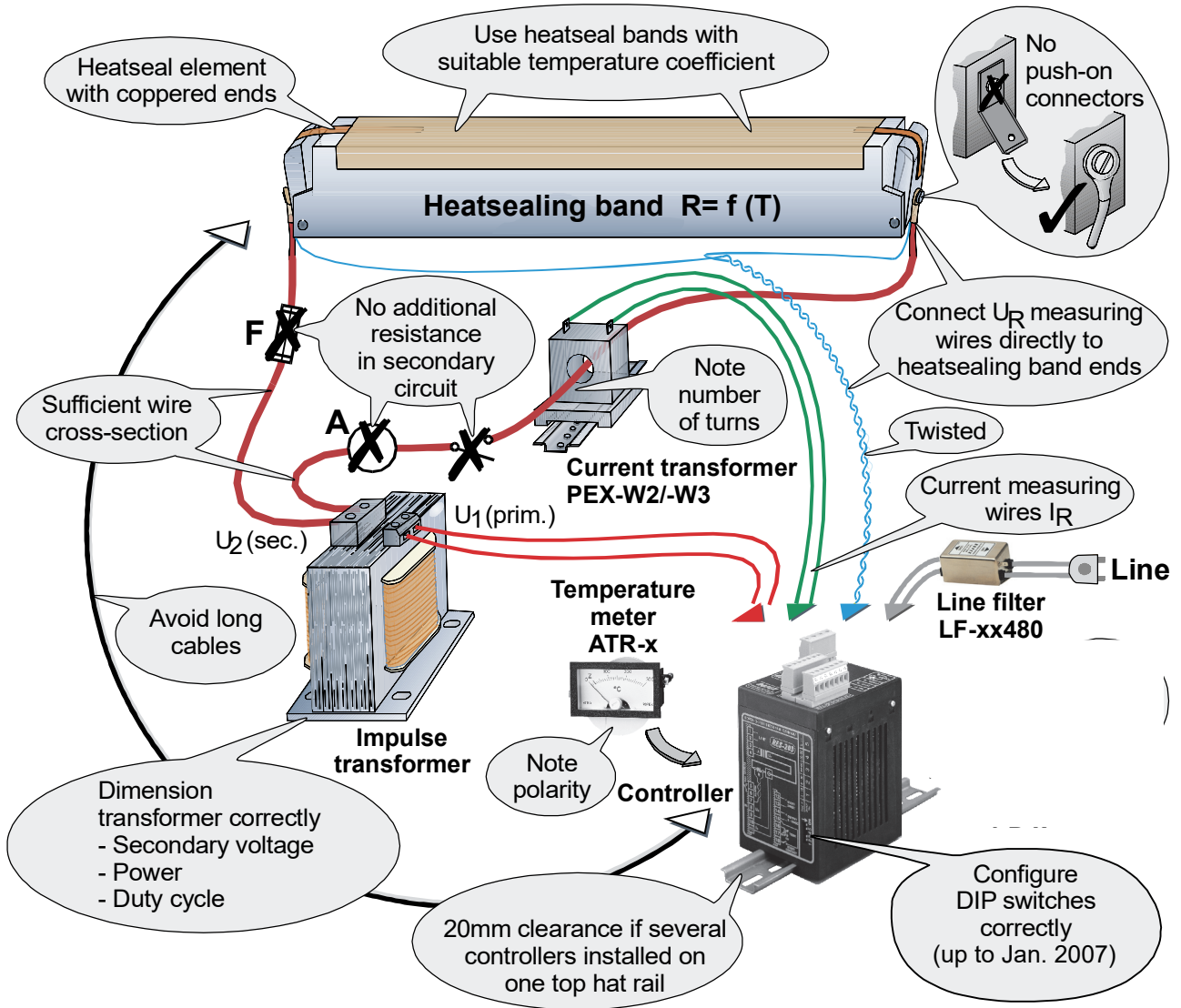

8.3 Power supply

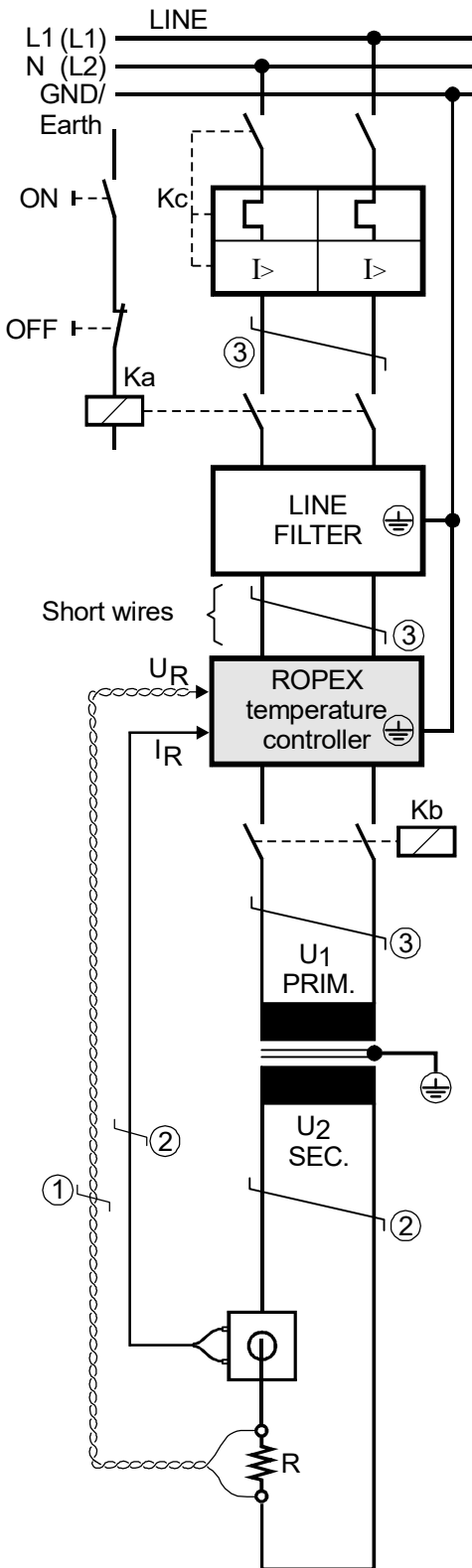

Line

Over-current protection

Double-pole circuit-breaker or fuses,
(☞ ROPEX Application Report)

⚠ Short-circuit protection only. RESISTRON® temperature controller not protected.

Relay Ka

For "HEAT ON - OFF" function (all-pole) or "EMERGENCY STOP".

Line filter

The filter type and size must be determined according to the load, the transformer and the machine wiring (☞ ROPEX Application Report).

⚠ Do not run the filter supply wires (line side) parallel to the filter output wires (load side).

RESISTRON® temperature controller

Relay Kb

Load break (all-pole), e.g. in combination with the alarm output of the temp. controller (ROPEX recommendation).

⚠ When using a series resistor RV-....-1 the relay Kb shall be installed.

Impulse Transformer

Designed according to EN 61558 (isolating transformer with reinforced insulation). Connect core to ground.

⚠ Use transformers with a one section bobbin. The power, duty cycle and voltage values must be determined individually according to the application (☞ ROPEX Application Report and "Accessories" leaflet for impulse transformers).

Wiring

The wire cross-sections depend on the application (☞ ROPEX Application Report).

- ① Wires must always be twisted (min. 20 turns/meter).
- ② These wires must be twisted (min. 20 turns/meter) if several control loops are laid together ("crosstalk").
- ③ Twisting (min. 20 turns/meter) is recommended to improve EMC.

8.4 Line filter

To comply with EMC directives – corresponding to EN 50081-1 and EN 50082-2 – RESISTRON control loops must be operated with line filters.

These filters damp the reaction of the phase-angle control on the line and protect the controller against line disturbances.



The use of a suitable line filter is part of the standards conformity and a prerequisite of the CE mark.

ROPEX line filters are specially optimized for use in RESISTRON control loops. Providing that they are installed and wired correctly, they guarantee compliance with the EMC limit values.

You can find the exact specification of the line filter in the ROPEX Application Report calculated for your particular heatsealing application.

For more technical information: ↪ "Line filter" documentation.

It is permissible to supply several RESISTRON control loops with a single line filter, providing the total current does not exceed the maximum current of the filter.

The wiring instructions contained in section 8.3 "Power supply" on page 17 must be observed.

Example drawing for LF-06480:

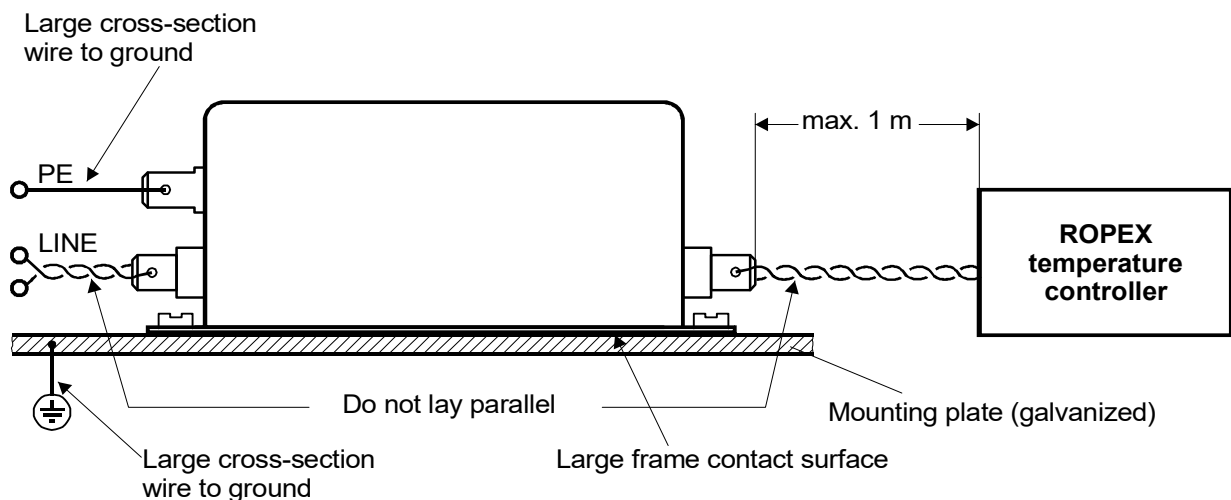

8.5 Current transformer PEX-W4/-W5

The PEX-W4/-W5 current transformer supplied with the RESISTRON[®] temperature controller is an integral part of the control system. The current transformer may only be operated if it is connected to the temperature controller correctly (↪ section 8.3 "Power supply" on page 17).

8.5.1 PEX-W4

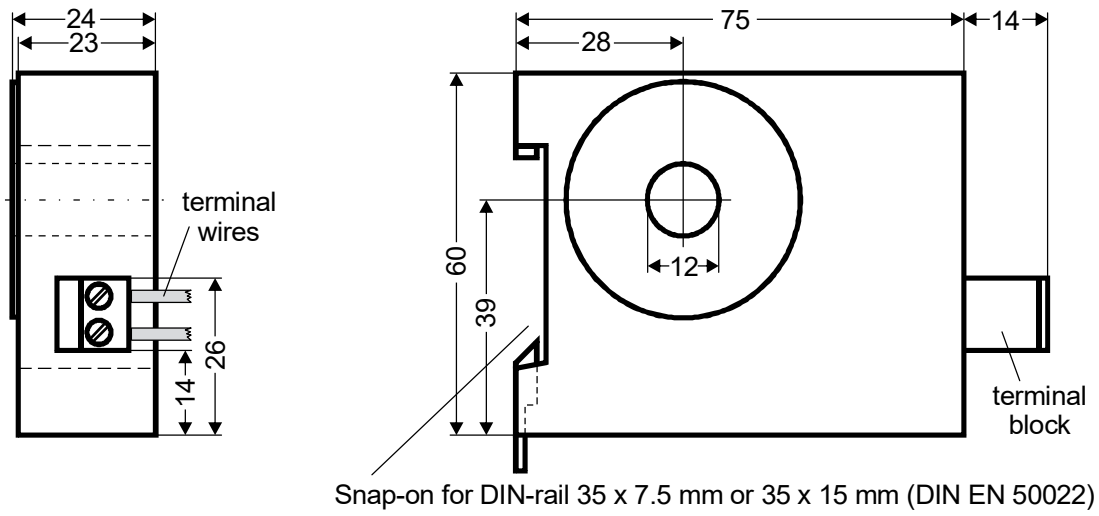

8.5.2 PEX-W5

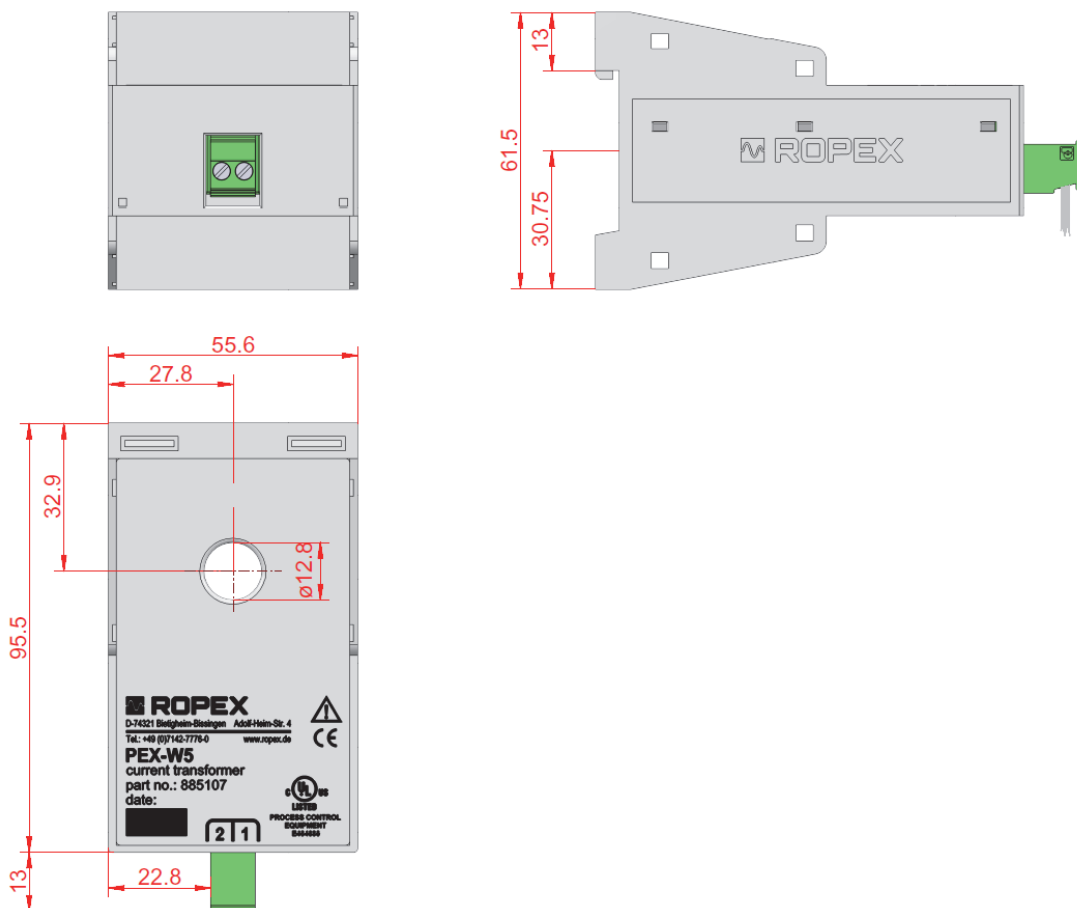

Mounting on DIN-rail 35 x 7.5 mm or 35 x 15 mm (DIN EN 50022).

8.6 Wiring diagram (standard)

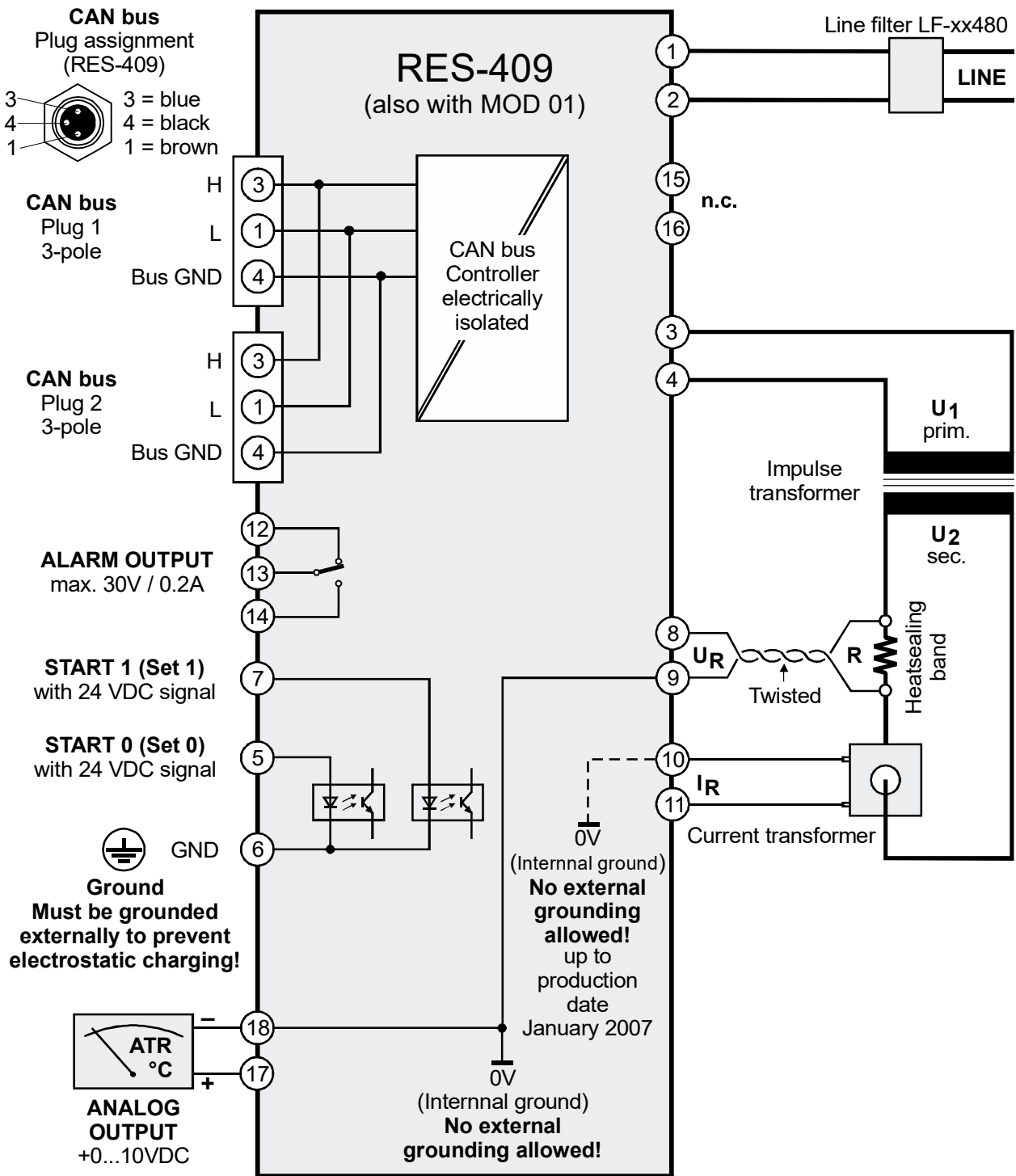

⚠ The START 0 and START 1 functions at terminals 5 and 7 are only available on controllers manufactured as of February 2007.

8.7 Wiring diagram with booster connection (MOD 26)

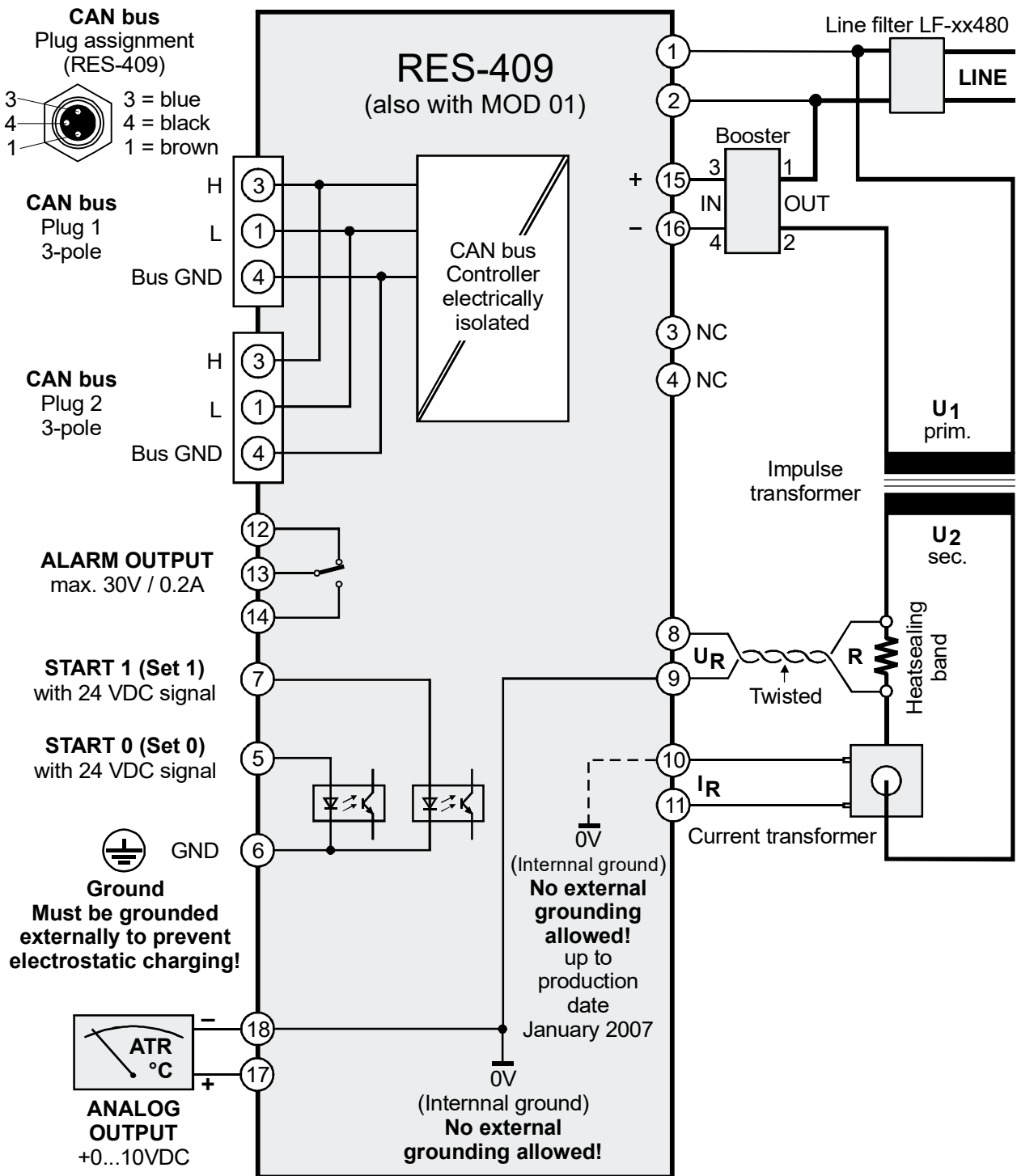

The START 0 and START 1 functions at terminals 5 and 7 are only available on controllers manufactured as of February 2007.

9 Startup and operation

9.1 View of the controller

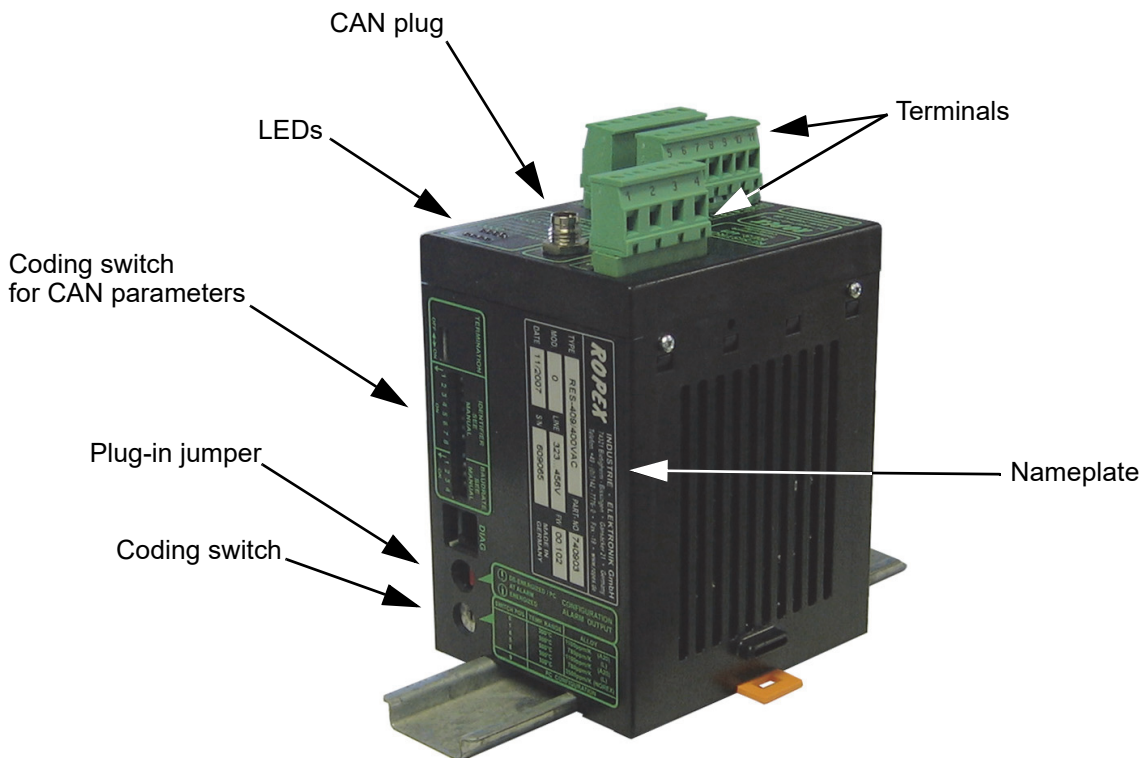

9.2 Controller configuration



The controller must be switched off in order to configure the coding switches and plug-in jumpers.

9.2.1 Configuration of the DIP switches for secondary voltage and current

Automatic configuration (AUTORANGE) (controllers manufactured as of February 2007)

The secondary voltage and current ranges are automatically configured by the automatic calibration function (AUTOCAL). The voltage is configured in the range from 0.4VAC to 120VAC and the current in the range from 30A to 500A. If the voltage and/or current are outside the permissible range, a detailed error message appears on the controller (↪ see section 10.16 "Error messages" on page 52).

Configuration with DIP switches (controllers manufactured up to January 2007)

Set the DIP switches for matching the secondary voltage U_2 and the secondary current I_2 to the correct position for **your** application.



You can find the exact configuration of the DIP switches in the ROPEX Application Report calculated for your particular application.

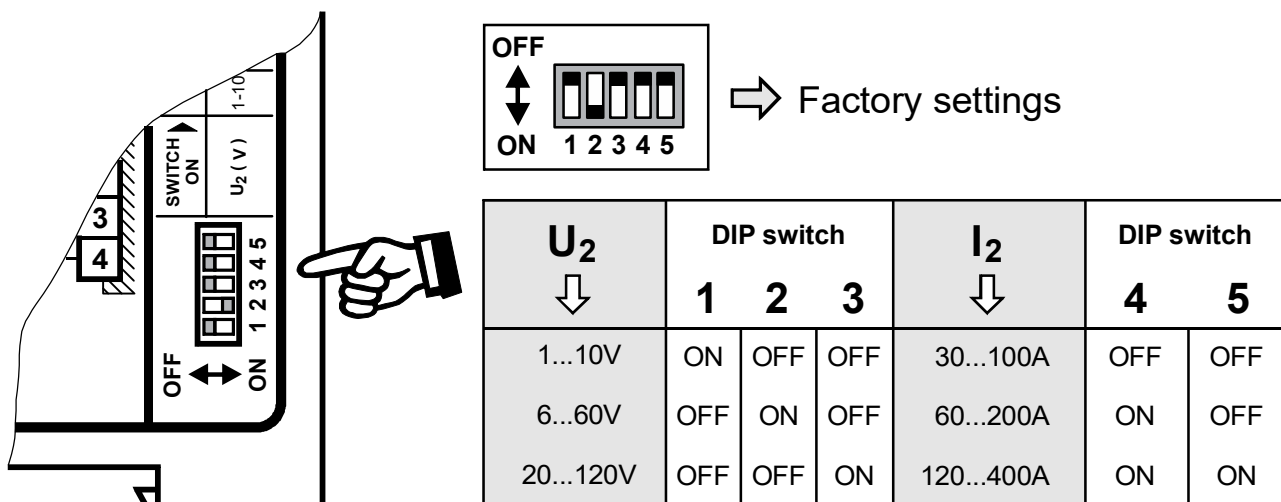

If the secondary current I₂ is less than 30A, the secondary high-current wire must be laid twice (or several times) through the PEX-W2 or PEX-W3 current transformer (↪ ROPEX Application Report).



9.2.2 Configuration of the rotary coding switch for the temperature range and alloy (as of January 2007)

Switch position	Temp. range	Temp. coefficient	Band alloy
0	300°C	1100ppm/K	e.g. A20
1	300°C	780ppm/K	e.g. L
4	500°C	1100ppm/K	e.g. A20
5	500°C	780ppm/K	e.g. L
8	300°C	3500ppm/K	
9	PC-CONFIGURATION		



0 = Factory settings

! This configuration is provided as standard on all controllers manufactured as of February 2007. On older controllers, the configuration must be set via the CAN interface (↪ section 10.3 "Receiving CAN messages" on page 32).

! All controllers manufactured as of February 2007:
 The settings with the rotary coding switch are considered to be the factory setting. This corresponds to CAN message address 8, value 10 (dec) (↪ section 10.3 "Receiving CAN messages" on page 32).

If the switch is set to "9" (as of February 2007), other temperature ranges and alloys can be selected in the ROPEX visualization software (↪ see section 10.12 "Diagnostic interface / visualization software (as of February 2007)")

on page 50). CAN message address 8 must contain the value 10 (dec) for this purpose (↪ see section 10.3 "Receiving CAN messages" on page 32).

9.2.3 Configuration of the fault relay

Alarm relay de-energized by alarm/ PC-CONFIGURATION.

Alarm relay energized by alarm. (factory setting)

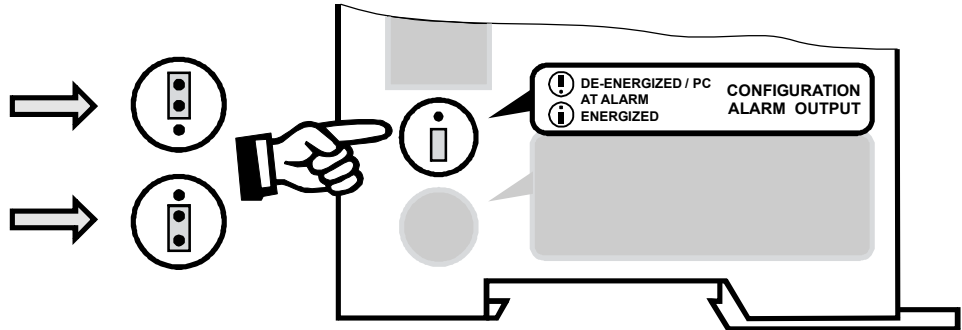

! If the jumper is not inserted, the fault relay is permanently energized (fault contact between terminals 13 and 14 closed). The other controller functions (e.g. heatsealing band heating, AUTOCAL etc.) are not affected.

If the "Fault output deenergized at fault/PC CONFIGURATION" position is selected (as of February 2007), the behavior of the fault output can be configured more finely in the ROPEX visualization software (↪ see section 10.12 "Diagnostic interface / visualization software (as of February 2007)" on page 50).

9.2.4 Configuration of the CAN interface

The CAN interface of the RES-409 is configured with DIP switches. The baud rate and some of the identifiers can be set. It is also possible to activate a terminating resistance.

! The CAN BUS-interface of the RES-409 supports CAN 2.0A according ISO 11898. CANopen is not supported.

All controllers manufactured as of February 2007:

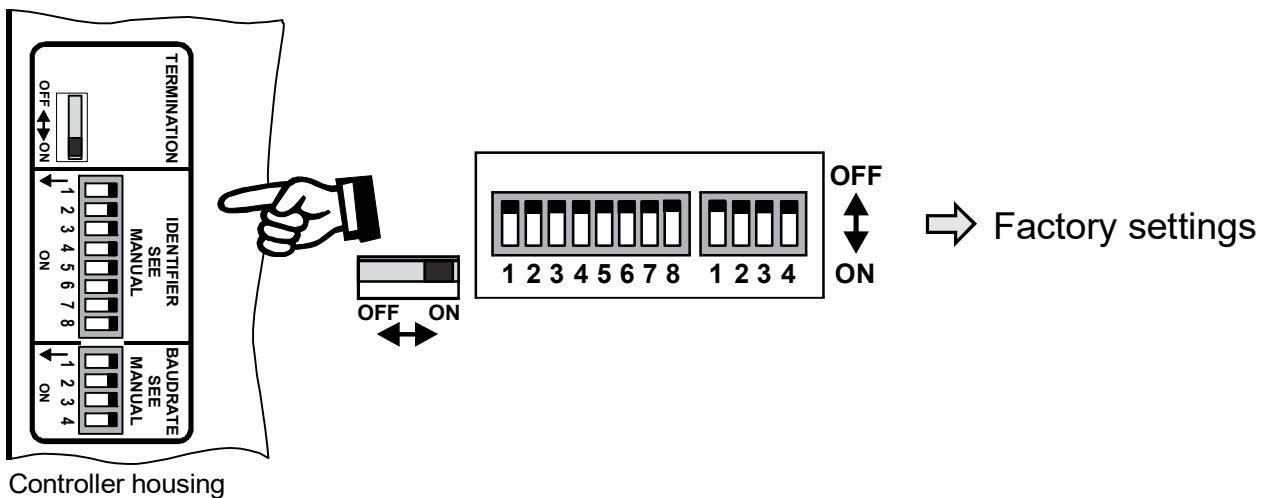

All controllers manufactured up to January 2007:

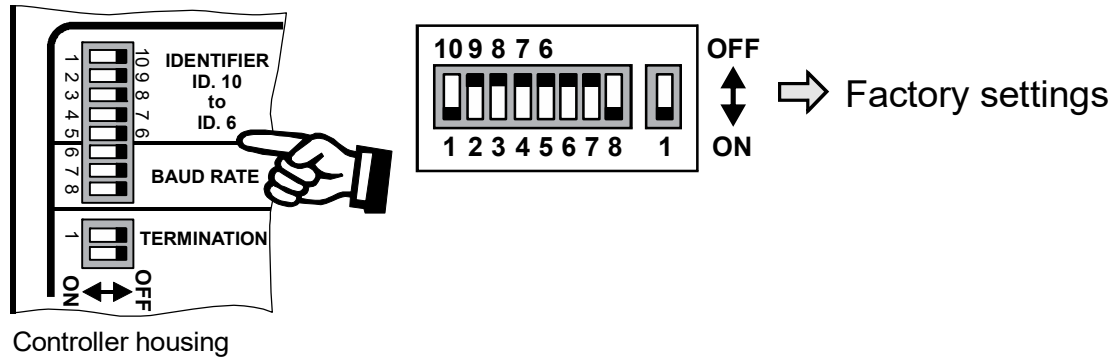

9.2.5 DIP switches for setting the baud rate

All controllers manufactured as of February 2007:

The following baud rates can be set for the CAN bus with the four-pole DIP switch:

Baud rate	DIP-4	DIP-3	DIP-2	DIP-1
AutoBaud (factory setting)	OFF	OFF	OFF	OFF
1MBaud	OFF	OFF	OFF	ON
800kBaud	OFF	OFF	ON	OFF
500kBaud	OFF	OFF	ON	ON
250kBaud	OFF	ON	OFF	OFF
205kBaud	OFF	ON	OFF	ON
125kBaud	OFF	ON	ON	OFF
100kBaud	OFF	ON	ON	ON
50kBaud	ON	OFF	OFF	OFF
20kBaud	ON	OFF	OFF	ON

The "AutoBaud" function (automatic baud rate detection) only works if the RES-409 controller is installed in a CAN network in which valid CAN messages are exchanged by at least two nodes. If the controller has already successfully "listened in" on a maximum of 8 CAN messages since being started up, it should by now have identified the correct baud rate and be capable of participating in the bus traffic. Until the correct baud rate is detected, the controller only plays a passive role on the CAN bus and has no influence on communications.

 The "NETWORK STATUS" LED (red) and the "MODULE STATUS" LED (green) blink (alternately) as long as the "AutoBaud" function is active.

 If the baud rate for the CAN network is changed while the controller is operating, it must be switched off and then on again in order to reactivate the "AutoBaud" function.

All controllers manufactured up to January 2007:

Various baud rates can be set for the CAN bus with DIP switches 6 to 8. The switch positions for the available baud rates are shown in the table below:

Baud rate	DIP-6	DIP-7	DIP-8
10kBaud	OFF	OFF	OFF
205kBaud (factory setting)	OFF	OFF	ON
50kBaud	OFF	ON	OFF
125kBaud	OFF	ON	ON
250kBaud	ON	OFF	OFF
500kBaud	ON	OFF	ON
800kBaud	ON	ON	OFF
1MBaud	ON	ON	ON

9.2.6 DIP switches for setting the identifiers



A new DIP switch setting does not take effect until the next time the controller is switched on.

All controllers manufactured as of February 2007:

The 8-pole DIP switch determines the 8 high bits of the 11-bit long standard CAN identifier. The 3 low bits are fixed. Since the identifier 0 must not be used, a maximum of 253 different controllers can be addressed in a CAN network.

The least significant identifier bit has a fixed value of 0 for receiving CAN messages:

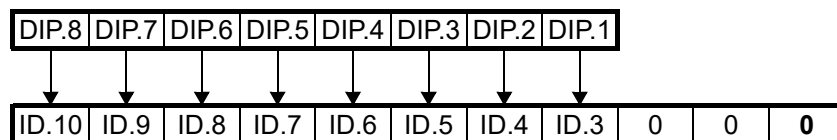

The least significant bit has a fixed value of 1 for sending CAN messages. The identifier for CAN messages sent by the RES-409, in other words, always has a value one higher than for received CAN messages.

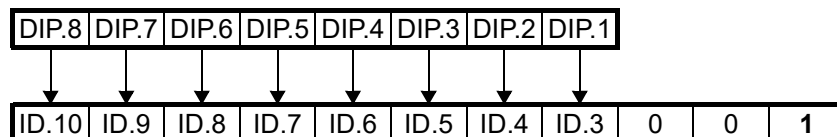

All controllers manufactured up to January 2007:

Switches 5...1 of the 8-pole DIP switch determine the 5 high bits of the 11-bit long standard CAN identifier. The 6 low bits are fixed. Since the identifier 0 must not be used, a maximum of 30 different controllers can be addressed in a CAN network.

The least significant identifier bit has a fixed value of 0 for receiving CAN messages:

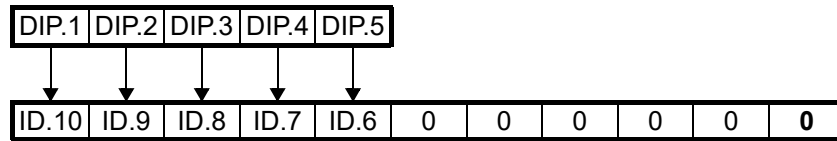

The least significant bit has a fixed value of 1 for sending CAN messages. The identifier for CAN messages sent by the RES-409, in other words, always has a value one higher than for received CAN messages.

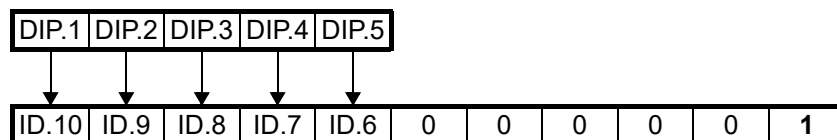

9.2.7 DIP switches for activating the terminating resistance

The "Termination" DIP switch can be used to switch a terminating resistance of 150ohms between the two CAN lines (CAN-L and CAN-H). This switch must be set to "ON" in order to activate the resistance.

9.3 Heatsealing band

9.3.1 General

The heatsealing band is a key component in the control loop, since it is both a heating element and a sensor. The geometry of the heatsealing band is too complex to be discussed at length here. We shall therefore only refer to a few of the most important physical and electrical properties.

The measuring principle applied for this system necessitates a heatsealing band alloy with a suitable temperature coefficient TCR, i.e. one whose resistance increases as the temperature rises.

Too low a TCR leads to oscillation or uncontrolled heating.

If a heatsealing band with a higher TCR is used, the controller must be specially calibrated.

The first time the heatsealing band is heated to approximately 200...250°C, the standard alloy undergoes a once-only resistance change (burn-in effect). The cold resistance of the heatsealing band is reduced by approximately 2...3%. However, this at first glance slight resistance change results in a zero point error of 20...30°C. The zero point must therefore be corrected after a few heating cycles (↪ section 9.3.2 "Burning in the heatsealing band" on page 27).

One very important design feature is the copper or silver-plating of the heatsealing band ends. Cold ends allow the temperature to be controlled precisely and increase the life of the teflon coating and the heatsealing band.

 **An overheated or burned-out heatsealing band must no longer be used because the TCR has been altered irreversibly.**

9.3.2 Burning in the heatsealing band

If a new heatsealing band has been used, the zero point is first of all calibrated while the band is still cold by activating the "AUTOCAL" function on the controller. When the "AUTOCAL" function has finished, the controller outputs the preselected calibration temperature (default value: 20°C) as the ACTUAL temperature at the analog actual value output as well as in the controller status. Adjust the set point to approximately 250°C and send a "START" command with a heatup time of approximately 1 second (↪ section 10.3.2 "START / STOP command "START" signal" on page 34). After cooling down again, the controller usually indicates a value less than 20°C. Repeat the "AUTOCAL" function. The heatsealing band has now been burned in and the change in the alloying properties stabilized.

The burn-in effect described here does not occur if the heatsealing band has already been thermally pretreated by the manufacturer.

9.3.3 Replacing the heatsealing band

All power supply leads must be disconnected from the RESISTRON[®] temperature controller in order to replace the heatsealing band.



The heatsealing band must be replaced in accordance with the instructions provided by the manufacturer.

Each time the heatsealing band is replaced, the zero point must be calibrated with the AUTOCAL function while the band is still cold, in order to compensate production-related resistance tolerances. The burn-in procedure described above must be performed for all new heatsealing bands.

9.4 Startup procedure

Please also refer to section 1 "General information" on page 3 and section 2 "Application" on page 7.



Installation and startup may only be performed by technically trained, skilled persons who are familiar with the associated risks and warranty provisions.

9.4.1 Initial startup

Prerequisites: The controller must be correctly installed and connected (↪ section 8 "Montage und Installation" on page 14).

Proceed as follows to start up the controller for the first time:

1. Switch off the line voltage and verify that all circuits are deenergized.
2. The supply voltage specified on the nameplate of the controller must be identical to the line voltage that is present in the plant or machine. The line frequency is automatically detected by the temperature controller in the range from 47 to 63Hz.
3. The settings of the coding switches on the controller depend on the ROPEX Application Report, the heatsealing band that is used, the required baud rate, and the identifier in the CAN network (↪ section 9.2 "Controller configuration" on page 22).
4. Make sure that no START command is being sent.
5. When the voltage is switched on, the yellow "AUTOCAL" LED lights up for approximately 0.3 seconds to indicate that the controller is being powered up correctly.



All controllers manufactured as of February 2007:

If the red "FAULT" LED lights up for 0.3s in addition to the yellow "AUTOCAL" LED when the voltage is switched on, the configuration of this controller has been changed in the visualization software (↪ section 10.12 "Diagnostic interface / visualization software (as of February 2007)" on page 50). In order to avoid malfunctions, please check the controller configuration before continuing the startup procedure.

6. One of the following states then appears:

"FAULT" LED	"OUTPUT" LED	ACTION
OFF	Short pulses every 1.2s	Go to 7
BLINKS fast (4Hz)	OFF	Go to 7
LIT continuously	OFF	Diagnose fault (↪ sect. 10.16)

7. Activate the AUTOCAL function by sending CAN message address 4, value 5 while the heatsealing band is still cold. The yellow "AUTOCAL" LED lights up for the duration of the calibration process (approx. 10...15s). A voltage of 0V simultaneously appears at the actual value output (terminals 17+18). If an ATR-x is connected, it indicates 0...3°C.

When the zero point has been calibrated, the "AUTOCAL" LED goes out and a voltage of 0.66V (300°C range) or 0.4V (500°C range) appears at the actual value output instead. If an ATR-x is connected, it must be set to "Z".

If the zero has not been calibrated successfully, the red "FAULT" LED blinks slowly (1Hz). In this case the controller configuration is incorrect (↪ section 9.2 "Controller configuration" on page 22 and ROPEX Application Report). Repeat the calibration after reconfiguring the controller correctly.

8. Burn in the heatsealing band (↪ section 9.3 "Heatsealing band" on page 27) and repeat the AUTOCAL function.

The controller is now ready

9.4.2 Restart after replacing the heatsealing band

To replace the heatsealing band, proceed as described in section 9.3 "Heatsealing band" on page 27.



Always use a heatsealing band with the correct alloy, dimensions and copper-plating in order to avoid malfunctions and overheating.

Continue with section 9.4, steps 4 to 8.

10 Controller functions

10.1 Indicators and controls

All controllers manufactured as of February 2007:

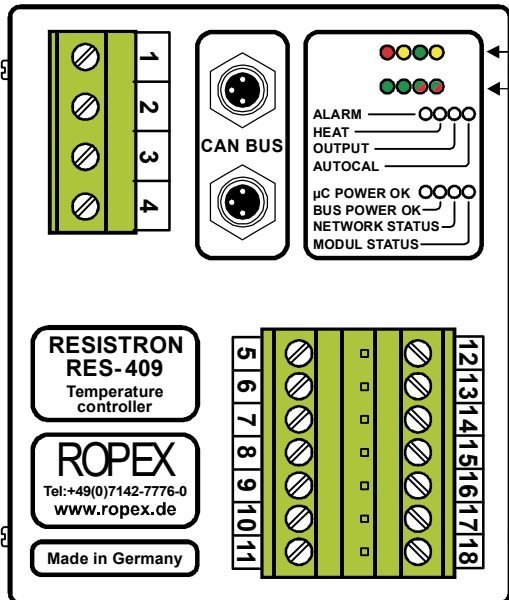

ALARM (red LED)	Lights up or blinks to indicate an alarm.
HEAT (yellow LED)	Lit during heating phase.
OUTPUT (green LED)	Indicates pulses in measurement mode. In control mode, luminous intensity is proportional to heating current.
AUTOCAL (yellow LED)	Remains lit for duration of AUTOCAL process.
μC PWR OK (green LED)	Lit if internal 5VDC power supply for the microcontroller is OK.
BUS PWR OK (green LED)	Lit if internal 5VDC power supply for the CAN bus interface is OK.
NETW STAT (Gn/red LED)	These two LEDs indicate the status of the CAN bus transmission as well as CAN bus error messages.
MODUL STAT (Gn/red LED)	

All controllers manufactured up to January 2007:

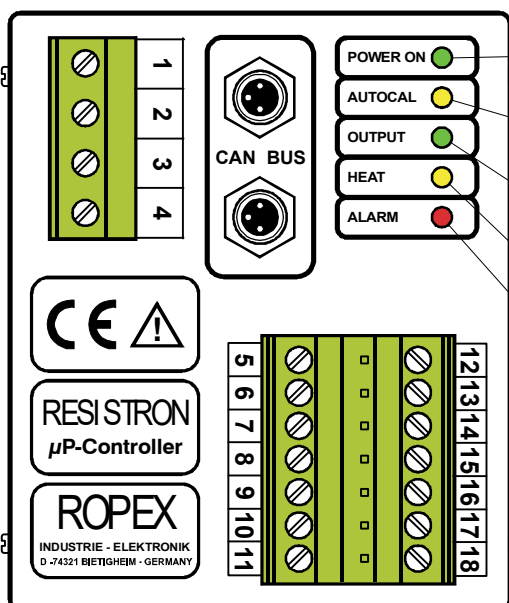

Green LED, remains lit as long as power supply is on .
Yellow LED, remains lit for duration of AUTOCAL process.
Green LED, indicates pulses in measurement mode. In control mode, luminous intensity is proportional to heating current.
Yellow LED, lit during heating phase.
Red LED, lights up or blinks to indicate ALARM.

In addition to the functions shown in the diagram above, various controller operating states are indicated by the LEDs. These states are described in detail in the table below:

LED	Blinks slowly (1Hz)	Blinks fast (4Hz)	Lit continuously
AUTOCAL (yellow)	Indicates undervoltage	AUTOCAL requested but function is locked (as of February 2007)	AUTOCAL is running
HEAT (yellow)	—	START requested but function is locked	START is running
OUTPUT (green)	In control mode, luminous intensity is proportional to heating current		
FAULT (red)	Configuration error, cannot run AUTOCAL	Controller calibrated incorrectly, run AUTOCAL	Error (↪ section 10.16)

As of February 2007 also:

LED	Blinks once (red)	Blinks twice (red)	Lit (red)	Lit (green)	NETWORK STATUS blinks (red) MODULE STATUS blinks (green) (alternately)
NETWORK STATUS (green/red)	CAN controller: Warning	CAN controller: Passive level	CAN controller: Bus off	Data transfer via CAN interface	AutoBaud active (↪ section 9.2.5)
MODULE STATUS (green/red)	—	—	—	Microcontroller status OK	

10.2 CAN protocol

 The following sections describe only controller-specific functions. For general information about the CAN bus and the system configuration, please refer to the description provided by your PLC manufacturer.

 The CAN BUS-interface of the RES-409 supports CAN 2.0A according ISO 11898. CANopen is not supported.

The CAN messages of the RES-409 always consist of 4 bytes. The first two bytes form a 16-bit address and the last two a 16-bit value:

Address.H	Address.L	Value.H	Value.L
Byte 1	Byte 2	Byte 3	Byte 4

"Address.H" is the first byte to be transferred while "value L" is transferred last.

10.3 Receiving CAN messages

The complete command set of the RES-409 is shown in the table below:

Address (hex)	Value (dec)	Meaning
0000	0...T _{max}	Store set point 0 (in °C)
0001	0...T _{max}	Store set point 1 (in °C)
0002	0...T _{max}	Store set point 2 (in °C)
0003	0...T _{max}	Store set point 3 (in °C)
		<u>As of February 2007:</u>
0100	0...T _{max}	Temporarily overwrite set point 0 (in °C)
0101	0...T _{max}	Temporarily overwrite set point 1 (in °C)
0102	0...T _{max}	Temporarily overwrite set point 2 (in °C)
0103	0...T _{max}	Temporarily overwrite set point 3 (in °C)
0004	0	Query set point 0 (in °C)
	1	Query set point 1 (in °C)
	2	Query set point 2 (in °C)
	3	Query set point 3 (in °C)
	4	Query controller status
	5	Run "AUTOCAL" function
	6	Run "Reset" after fault
	7	Query current actual value
	8	Query controller number, part 1
	9	Query controller number, part 2
	10	Query calibration temperature
	11	Query current upper temperature monitoring value (see value 22)
	12	Query current value of heatsealing band alloy/temperature range
		<u>As of February 2007:</u>
	13	Query current fault and AUTOCAL status
	14	Query current hold mode setting
	15	Query current "AUTOCOMP" status
	16	Query maximum set point
	17	Query current software revision
	18	Query current software version (default value: 00)
	19	Query current variable temperature coefficient (TCR in ppm/K)
	20	Query current configuration of "Temperature OK" bit
	21	Query current lower temperature monitoring value
	22	Query current upper temperature monitoring value
	23	Query current configuration of temperature diagnosis
	24	Query current value of temperature diagnosis delay (in 0.1 s units)
	25	Query current configuration of heatup timeout (in 0.1 s units)
	26	Query current value of measuring impulse length (in 0.1 s units)
	27	Query current value of temperature range
	28	Query current controller type (as of software revision 102)
	256	Preset temporary set point 0 to stored set point 0
	257	Preset temporary set point 1 to stored set point 1
	258	Preset temporary set point 2 to stored set point 2
	259	Preset temporary set point 3 to stored set point 3

Address (hex)	Value (dec)	Meaning
0005	Heatup time and set point	START with specification of heatup time and selection of set point Premature "STOP" if heatup time = 0 (↪ section 10.3.2 "START / STOP command "START" signal" on page 34)
0006	0...40	Store calibration temperature (in °C)
0007	<u>As of Feb. 2007:</u> 3...99 <u>Up to Jan. 2007:</u> 3...20	Store temperature monitoring values (in K), simultaneously changes upper and lower temperature tolerance band limits
0008	0 1 2 3 4 5 6 7 10 11 12 13 14 15	Store alloy/range (heatsealing band alloy TCR/temperature range): TCR = 1100ppm/K, max. temperature range 200 °C TCR = 1100ppm/K, max. temperature range 300 °C TCR = 1100ppm/K, max. temperature range 400 °C TCR = 1100ppm/K, max. temperature range 500 °C TCR = 3500ppm/K, max. temperature range 200 °C TCR = 3500ppm/K, max. temperature range 300 °C <u>As of February 2007:</u> TCR = 3500ppm/K, max. temperature range 400 °C TCR = 3500ppm/K, max. temperature range 500 °C Rotary coding switch setting applies TCR, temperature range, max. set point is variable (see addresses 000A, 000B, 0014) TCR = 780ppm/K, max. temperature range 200 °C TCR = 780ppm/K, max. temperature range 300 °C TCR = 780ppm/K, max. temperature range 400 °C TCR = 780ppm/K, max. temperature range 500 °C
The following CAN messages are only available on controllers manufactured as of February 2007:		
0009	0 1 2	Hold mode: OFF Hold mode: ON Hold mode: 2 seconds (↪ section 10.6 "Hold mode" on page 43)
000A	400...4000	Variable temperature coefficient (TCR in ppm/K) (applies if address 0008 contained the value 11 (dec))
000B	200...500	Maximum set point (in °C) (applies if address 0008 contained the value 11 (dec))
000C	0 1 2	"Temperature OK" bit: OFF "Temperature OK" bit: ON if set = actual "Temperature OK" bit: ON if set = actual with latch function (↪ section 10.9 "Temperature monitoring / "temperature OK" bit (as of February 2007)" on page 47)
000D	3...99	Store lower temperature tolerance band limit
000E	3...99	Store upper temperature tolerance band limit

Address (hex)	Value (dec)	Meaning
000F	0 1	Temperature diagnosis: OFF Temperature diagnosis: ON (↪ section 10.10 "Temperature diagnosis (as of February 2007)" on page 48)
0010	0...99	Temperature diagnosis delay in 0.1 s (↪ section 10.10 "Temperature diagnosis (as of February 2007)" on page 48)
0011	0...999	Heatup timeout (0 = OFF) in 0.1 s (↪ section 10.11 "Heatup timeout (as of February 2007)" on page 49)
0012	17...30	Measuring impulse length in 0.1 ms (↪ section 10.7 "Measuring impulse length (as of February 2007)" on page 45)
0013	0 1 2	AUTOCOMP: OFF AUTOCOMP: ON AUTOCOMP: AUTO (as of software revision 102) (↪ section 10.8 "Automatic phase compensation (AUTOCOMP, as of February 2007)" on page 45)
0014	0 1 2 3	Temperature range 200°C Temperature range 300°C Temperature range 400°C Temperature range 500°C (applies if address 0008 contained the value 11 (dec))
F002	Any	All parameters have factory setting (↪ section 11 "Factory settings" on page 58)

10.3.1 Temperature setting (set point selection)

Up to four different set points can be permanently stored in the RES-409. The stored values are not lost if the power supply is interrupted. They can be reloaded on request. It is possible to switch between preheat and main heat, for instance, or to increase the temperature to a particular set point gradually in a series of steps ("ramp") simply by programming the set points accordingly. The maximum settable set point T_{max} is dependent on the selected temperature range (see CAN message address 8 and CAN message address 4, value 12). Temperature ranges of 200°C, 300°C, 400°C and 500°C, can be defined here.

All set points greater than T_{max} are rejected by RES-409 controllers manufactured up to January 2007. In this case, the last stored set point remains valid.

The set point is limited to T_{max} and subsequently stored on controllers manufactured as of February 2007. If "Alloy/range" (CAN message address 8) is set to "Variable" (value 11), T_{max} is determined by the selected temperature range (CAN message address 13_h) and the value stored under "Maximum set point" (CAN message B).

The set point selected for the heatsealing temperature must be greater than 40°C. If not, the heatsealing band is not heated when the start/stop command is activated.

10.3.2 START / STOP command "START" signal

 **A "START" command or a "START" signal is rejected ("HEAT" LED blinks fast) if the "AUTOCAL" function is running or a "RESET" command is active.**

The fault output is switched if a "START" command (or the "START" signal) is activated while a warning message with error codes 8...12 (as of February 2007 also: 104...106, 111...114, 211, 302, 303) is displayed (↪ section 10.16 "Error messages" on page 52). The heatsealing band is no longer heated.

By means of the CAN protocol:

The "Value" parameter in the START command (address 5) has the following structure:

Bit no.	Name	Meaning
Bits 0...7	Heatup time	Time in 10ms steps until the control process is automatically deactivated (at least 50ms).
Bits 8...9	Set point	Number of the required set point (0...3)
Bits 10...15	Not assigned	

The START command is only accepted if there are no faults and the "AUTOCAL" function is not running (↪ section 10.4.1 "Controller status" on page 39). The number of the required set point and the maximum heatup time (50ms...2550ms) are transferred together with the START command. If the controller must heat for longer than 2550ms (e.g. for continuous heating), a new START command must be sent before the end of the heatup time. This mechanism ensures that the controller does not heat in an uncontrolled way for long periods if there is no CAN communication. The heating phase can be prematurely terminated by sending a START command with a heatup time < 5 (corresponds to < 50ms), whereby the set point number is irrelevant. The controller then stops the heating phase immediately and changes to measuring mode.

Each START/STOP command is answered with an acknowledgment message (address 9), which also contains the 6 low bits of the controller status in addition to the actual temperature value.

By means of a 24VDC control signal (controllers manufactured as of February 2007):

A START/STOP command for set points 0 and 1 can also be activated by means of a digital 24VDC control signal (START 0 or START 1). When a "START" signal is activated, the controller-internal set/actual comparison is enabled and the heatsealing band is heated to the SET temperature. It remains at this temperature until the signal is deactivated again.

The "HEAT" LED on the front panel of the RES-409 is lit continuously for the duration of the heating phase.

The "START" signal (START 0) for set point 0 is activated by applying a 24VDC signal at terminals 5+6.

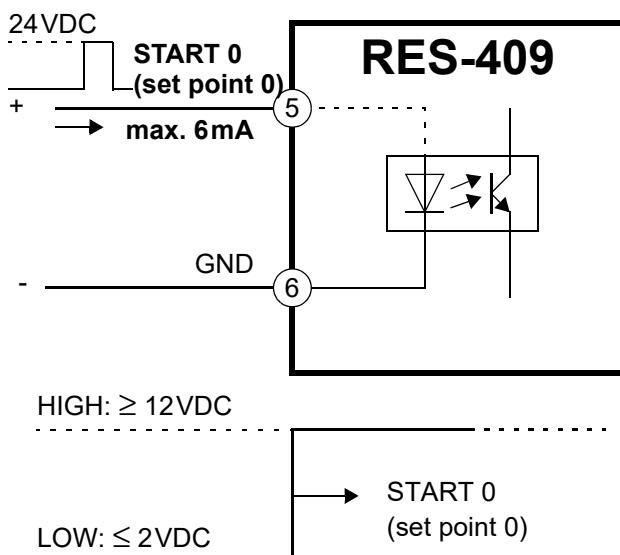

The "START" signal (START 1) for set point 1 is activated by applying a 24VDC signal at terminals 7+8.

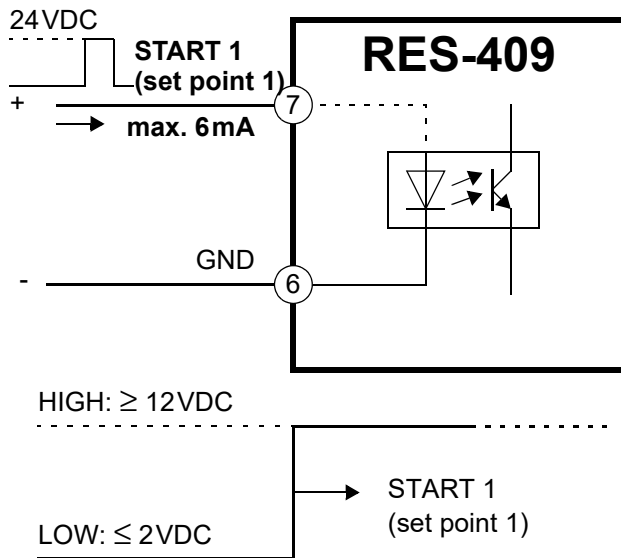

The set point selected for the heatsealing temperature must be greater than 40°C. If not, the heatsealing band is not heated ("HEAT" LED blinks).

The fault output is switched if a "START" command (or the "START" signal) is activated while a warning message with error codes 8...12 (as of February 2007 also: 104...106, 111...114, 211, 302, 303) is displayed (↪ section 10.16 "Error messages" on page 52). The heatsealing band is no longer heated.

⚠ The 24VDC "START 0" signal has the highest priority and overwrites the values specified by both the 24VDC "START 1" signal and all "START" commands sent via the CAN interface.

The 24VDC "START 1" signal has the lowest priority. All START sent commands via the CAN interface and the 24VDC "START 0" signal have higher priority.

10.3.3 Automatic zero calibration (AUTOCAL)

Owing to the automatic zero calibration (AUTOCAL) function, there is no need to adjust the zero point manually on the controller. The "AUTOCAL" function matches the controller to the current and voltage signals that are present in the system.

The automatic calibration process takes around 10...15 seconds. The heatsealing band is not heated.

The yellow LED on the front panel lights up when the "AUTOCAL" function is active. The actual value output (terminals 17+18) is set to 0...3°C (corresponds to approx. 0VDC).

If the temperature of the heatsealing band varies on controllers manufactured as of February 2007, the "AUTOCAL" function is run a maximum of three times. If the function still cannot be executed successfully, an error message appears (error code 114; ↪ section 10.16 "Error messages" on page 52).

The initial temperature (ambient temperature) of the heatsealing bar(s) which is currently valid for calibration can be set in the 0...40°C range. The CAN message "Store calibration temperature" (address 6, receive) is used for this purpose. The last stored calibration temperature is displayed as the CAN message "Actual calibration temperature" (address 8, send). The default value is 20°C.

The CAN message for starting the "AUTOCAL" function (address 4, value 5) is executed by the controller immediately providing the "AUTOCAL" function is not locked. "AUTOCAL active" appears in the controller status.

⚠ You should always wait for the heatsealing band and the bar to cool down (to ambient temperature) before running the "AUTOCAL" function.

Reasons for locked "AUTOCAL" function:

1. The "AUTOCAL" function cannot be activated until 10seconds after the controller is switched on. If you attempt to run it sooner, it will not work.
2. The "AUTOCAL" function cannot be activated if the heatsealing band cools down at a rate of more than 0.1K/s.
3. The "AUTOCAL" function is not run until the end of the heatup time ("HEAT" LED lit).
4. If the "RESET" signal (24VDC) is activated, the "AUTOCAL" function is not executed.
5. Directly after the controller is powered up, the "AUTOCAL" function cannot be run if error codes 1...3, 5...7 (as of February 2007 also: 101...103, 201...203, 801, 9xx) are displayed (↪ section 10.16 "Error messages" on page 52). If the controller has already operated correctly – a minimum of once – after powering up, the "AUTOCAL" function cannot be run if error codes 5...7x (as of February 2007 also: 201...203, 801, 9xx) are displayed.

If the "AUTOCAL" function is temporarily locked, the request is stored. As soon as "AUTOCAL" is allowed again, the function is started and "AUTOCAL active" appears in the controller status.

If a START or STOP command is received between the "AUTOCAL" request and the actual start of the "AUTOCAL" function, the "AUTOCAL" request is canceled again and the START or STOP command is executed instead.

10.3.4 Alloy / range (heatsealing band alloy TCR / temperature range)

The RES-409 can be configured for different heatsealing band alloys and temperature ranges (T_{max}) with CAN message address 8. The set heatsealing band alloy and temperature range are permanently stored in the controller and are not lost even if the power supply fails. The current setting can be reloaded by means of CAN message address 11. The controller is delivered with the setting "1", in other words TCR = 1100ppm and temperature range = 300°C.

If "Alloy/range" (CAN message address 8) is set to "Variable" (value 11), you can now specify the temperature coefficient TCR of the heatsealing band material with CAN message address A, the temperature range with CAN message address 14_h, and the maximum permissible set point T_{max} with CAN message address 13_h.

If a set point which is higher than the maximum permissible temperature T_{max} is selected, it is either limited to the maximum value (controllers manufactured as of February 2007) or ignored (controllers manufactured up to January 2007).

The scale of the analog output for the ACTUAL temperature is dependent on the selected temperature range:

Temperature range	Scale
200°C and 300°C	0...10VDC (corresponds to 0...300°C)
400°C and 500°C	0...10VDC (corresponds to 0...500°C)

 **You must always run the "AUTOCAL" function after changing the alloy/range.**

10.3.5 RESET command

This command is used to reset the controller. If the controller reports a fault (↪ section 10.4.1 "Controller status" on page 39), it must be reset with this command (and possibly also with an AUTOCAL command).

If a communication problem occurs, the controller must be reset by briefly disconnecting it from the power supply.

 **The controller runs an internal initialization lasting approximately 500ms after the "RESET" command is received. The next heatsealing process cannot be started until it has finished.**

! If a contactor Kb is used to deactivate the control loop (↪ section 8.3 "Power supply" on page 17), it must be reliably energized again 200ms at the latest after the "RESET" command is received (note the contactor switching and delay times). If it is energized too late, an error message will be output by the controller.

10.3.6 Querying the ACTUAL temperature

If the RES-409 receives a command requesting the actual value, it returns the current ACTUAL temperature in °C. Negative temperatures are identified by the "sign" bit (most significant bit).

10.4 Sending CAN messages

The send command set of the RES-409 is shown in the table below:

Address (hex)	Value (dec)	Meaning
0000	0...T _{max}	Current set point 0 (in °C)
0001	0...T _{max}	Current set point 1 (in °C)
0002	0...T _{max}	Current set point 2 (in °C)
0003	0...T _{max}	Current set point 3(in °C)
0004	-20...T _{max}	Current actual value (in °C)
0005	(↪ 10.4.1)	Full current controller status
0006	3 digits (BCD coded)	Digits 1...3 of 6-digit controller number
0007	3 digits (BCD coded)	Digits 4...6 of 6-digit controller number
0008	0...40	Current calibration temperature (in °C)
0009	(↪ 10.4.2)	Acknowledgment message (current actual value with reduced controller status)
000A	<u>As of Feb. 2007:</u> 3...99 <u>Up to Jan. 2007:</u> 3...20	Current upper temperature tolerance band limit
000B	0...5 (↪ 10.3)	Current heatsealing band alloy/temperature range
The following CAN messages are only available on controllers manufactured as of February 2007:		
000C	0...65535	Current fault and AUTOCAL status (↪ section 10.4.3 "Fault / AUTOCAL status (as of February 2007)" on page 41)
000D	0...2	Hold mode: 0=OFF, 1=ON, 2=2 seconds
000E	0, 1	AUTOCOMP status: 0=OFF, 1=ON
000F	0...500	Maximum set point
0010	0...999	Software revision
0011	0...99	Software version (default value: 00)

Address (hex)	Value (dec)	Meaning
0012	400...4000	Current variable temperature coefficient (TCR in ppm/K)
0013	0...2	"Temperature OK" bit: 0=OFF, 1=active if set = act, 2=active if set = act with latch function
0014	3...99	Lower temperature tolerance band limit
0015	3...99	Upper temperature tolerance band limit
0016	0, 1	Temperature diagnosis: 0=OFF, 1=ON
0017	0...99	Temperature diagnosis delay in 0.1 s
0018	0...999	Heatup timeout in 0.1 s
0019	17...30	Measuring impulse length in 0.1 ms
001A	0...3	Temperature range: 0=200°C, 1=300°C, 2=400°C, 3=500°C
001B	0...15	Current controller type (RES-409 = value 7)

10.4.1 Controller status

The controller status is sent on request. It contains all important information about the controller. If a fault occurs, it can be accurately diagnosed with the help of the error message (↪ section 10.16 "Error messages" on page 52). The controller status is coded as follows:

Bit no.	Name	Meaning
0...1	Set point no.	Number of the last set point used (0...3)
2	Controller active	0: Measuring mode 1: Control mode
3	Temperature OK	0: Actual value outside specified temperature tolerance band 1: Actual value inside specified temperature tolerance band
4	Fault	0: No fault 1: Fault active
5	AUTOCAL locked	0: "AUTOCAL" function allowed 1: "AUTOCAL" function not allowed (cooling phase)
6	AUTOCAL active	0: "AUTOCAL" function not running 1: "AUTOCAL" function is running
7	<u>As of Feb. 2007:</u> Hold active <u>Up to Jan. 2007:</u> Not used	0: Hold is not active 1: Hold is active Not assigned
8...11	Error message	Error codes 0...13 (↪ section 10.16 "Error messages" on page 52)
The following status information is only available on controllers manufactured as of February 2007:		
12	START requested	A START request was received

Bit no.	Name	Meaning
13	Start input	0: External start input "START with set 0" is started 1: External start input "START with set 1" is started
14	Undervoltage	0: Line voltage is inside operating range 1: Line voltage is too low (undervoltage)
15	Temperature reached	This status bit is set if the actual temperature exceeds 95% of the set temperature. As soon as the control mode is exited or an alarm is signaled, this status bit is reset again.

10.4.2 Acknowledgment message

The RES-409 automatically sends an acknowledgment message (address 9) after every START/STOP command. This message contains the current actual value and the most important status information:

Bit no.	Name	Meaning
0...8	Actual value	Current actual value (in °C)
9	Sign	Sign of the actual value. 0: positive, 1: negative
10...11	Set point no.	Number of the last set point used (0...3)
12	Controller active	0: Measuring mode 1: Control mode
13	"Temperature OK" bit	0: Actual value outside specified temperature tolerance band 1: Actual value inside specified temperature tolerance band
14	Fault	0: No fault 1: Fault active
15	AUTOCAL locked	0: "AUTOCAL" function allowed 1: "AUTOCAL" function not allowed (cooling phase)

10.4.3 Fault / AUTOCAL status (as of February 2007)

Bit no.	Name	Meaning
0...9	Error code	Three-digit error code
10...11	Error action	0: Run "RESET" 1: Run "AUTOCAL" 2: Check configuration
12...15	AUTOCAL status	0: "AUTOCAL" function allowed (not active and not locked) 1: "AUTOCAL" function is active 2: Check for falling actual value 3: Wait until "AUTOCAL" request is canceled 4: Wait in case "AUTOCOMP" is started 5: "AUTOCOMP" function is active 6: "AUTOCAL" function is locked because heatsealing band is still hot 7: "AUTOCAL" function is locked because "START" is active 8: "AUTOCAL" function is locked because "PREHEAT" is active 9: "AUTOCAL" function is locked because "DETACH" is active (not used) 10: "AUTOCAL" function is locked because "RESET" is active 11: "AUTOCAL" function is locked because fault is active 12: "AUTOCAL" function is canceled

10.4.4 Controller number (serial number)

The controller number is individually assigned to each device and can be used to uniquely identify the RESISTRON[®] temperature controller in a CAN network. It is divided into two parts, in order to comply with the message format (↪ section 10.2 "CAN protocol" on page 31). Each part consists of three digits, which are stored in BCD format in "value.H" and "value.L".

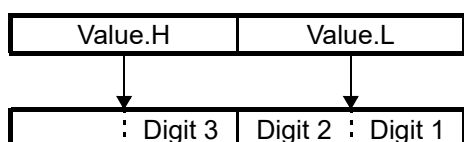

10.5 Temperature meter (actual value output)

The RES-409 supplies an analog 0...10VDC signal, which is proportional to the real ACTUAL temperature, at terminals 17+18.

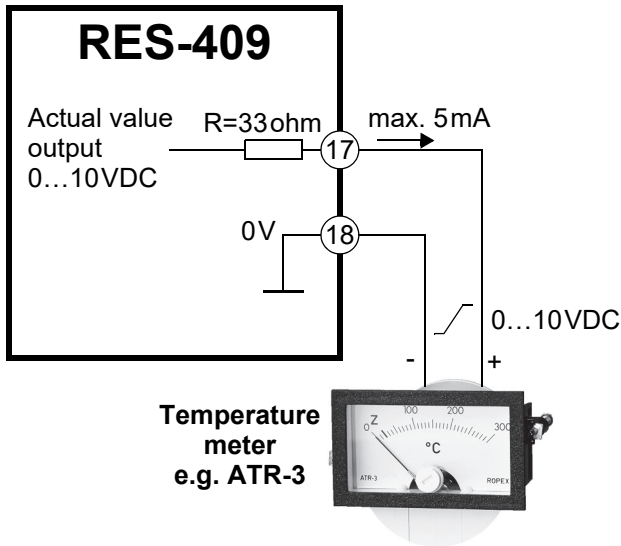

Voltage values:

0VDC → 0°C

10VDC → 300°C or 500°C

(depending on controller configuration)

The relationship between the change in the output voltage and the ACTUAL temperature is linear.

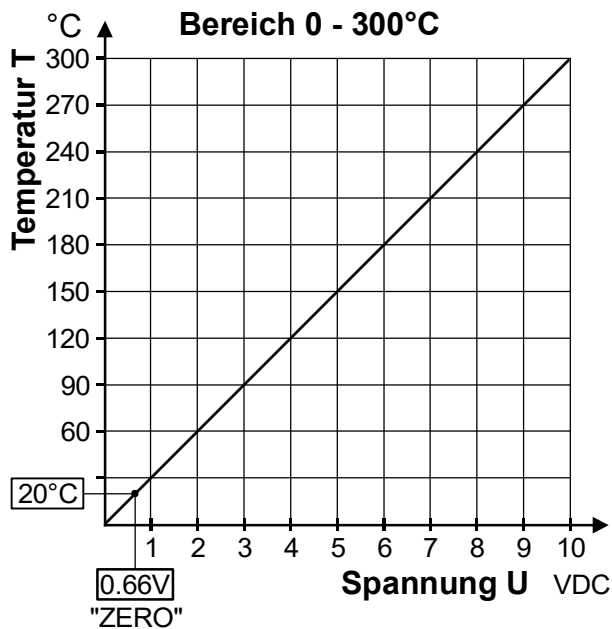

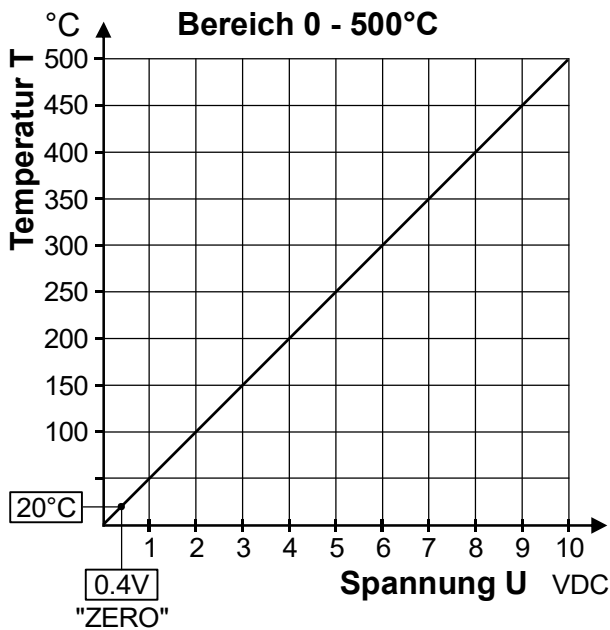

Only the 300°C and 500°C temperature ranges appear at this actual value output. If a temperature range of 200°C is set with CAN message address 8 ("Alloy/range"), it appears at this output in the 0...300°C range. A 400°C temperature range is indicated as 0...500°C.

An indicating instrument can be connected to the output in order to visualize the temperature of the heatsealing band.

The characteristics of the ROPEX ATR-x temperature meter (size, scaling, dynamic response) are ideally suited to this application and this instrument should therefore always be used (↪ section 5 "Accessories and modifications" on page 9).

The meter not only facilitates SET-ACTUAL comparisons but also enables other criteria such as the heating rate, set point reached within the specified time, heatsealing band cooling etc. to be evaluated.

This instrument additionally permits disturbances in the control loop (loose connections, contacting or wiring problems) as well as any line disturbances to be efficiently monitored and accurately interpreted. The same applies if mutual interference occurs between several neighboring control loops.

⚠ This output is not potential-free and can carry the secondary voltage of the impulse transformer. External grounding is not allowed. If this warning is ignored, the controller will be damaged by frame currents. Shock protection must be provided.

If a fault occurs, this analog output is used to display selective error messages (↪ section 10.16 "Error messages" on page 52).

10.6 Hold mode

The ACTUAL temperature query via the CAN interface (↪ section 10.3.6 "Querying the ACTUAL temperature" on page 38) can be set in CAN message address 9 (↪ section 10.3 "Receiving CAN messages" on page 32). The following settings are possible:

1. "OFF" (factory setting)

The currently measured ACTUAL temperature is transferred via the CAN interface when the ACTUAL temperature is queried.

2. "ON"

The ACTUAL temperature at the end of the last heating phase is transferred when the ACTUAL temperature is queried. When the controller is powered up, the real ACTUAL temperature is initially transferred until the end of the first heating phase.

3. "2 seconds"

The current ACTUAL temperature is transferred for an additional 2 seconds at the end of a heating phase if it is queried via the CAN interface. The ACTUAL temperature is then transferred again in real time until the end of the next heating phase.

! Hold mode only applies to queries via the CAN interface. The ACTUAL temperature always appears in real time at the analog actual value output.

The various hold modes are shown below:

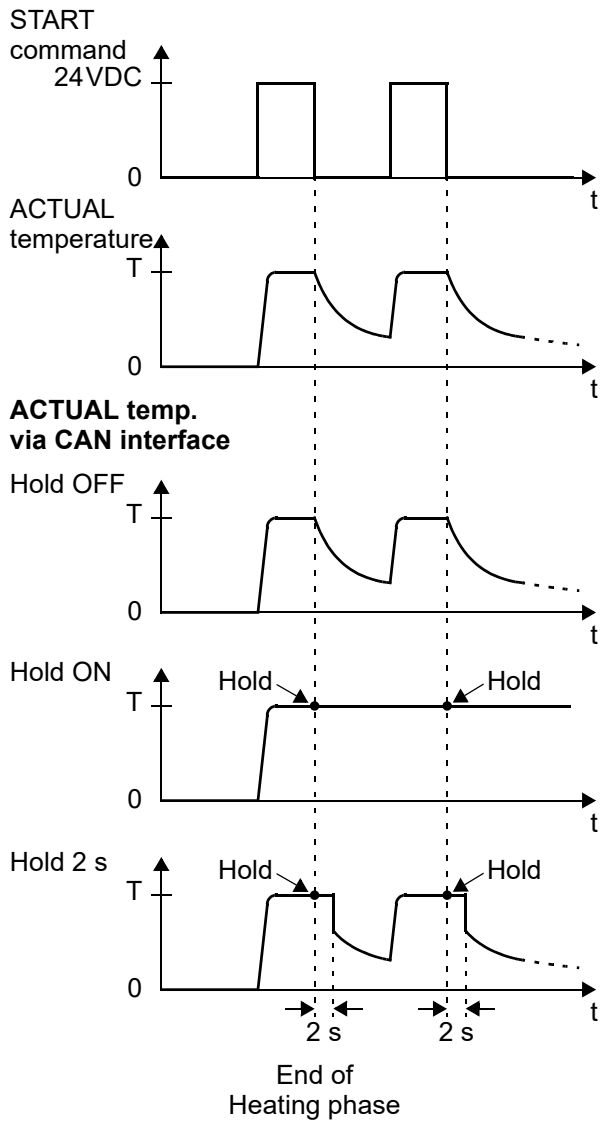

10.7 Measuring impulse length (as of February 2007)

The length of the measuring impulses generated by the controller can be set with this parameter (CAN message address 12). It may be necessary to set a measuring impulse that is longer than the default 1.7ms for certain applications (↪ ROPEX Application Report).

 **This parameter can be set either via the CAN interface (CAN message address 12) or in the ROPEX visualization software (↪ section 10.12 "Diagnostic interface / visualization software (as of February 2007)" on page 50).**

10.8 Automatic phase compensation (AUTOCOMP, as of February 2007)

It may be necessary to compensate the phase angle displacement between the U_R and I_R measuring signals in certain heatsealing applications (↪ ROPEX Application Report). The "AUTOCOMP" function is provided for this purpose (CAN message address 13).

The following settings are possible:

1. **"OFF"** (factory setting)

The "AUTOCOMP" function is deactivated

2. **"ON"**

The "AUTOCOMP" function is executed whenever the "AUTOCAL" function (↪ section 10.3.3 "Automatic zero calibration (AUTOCAL)" on page 36) is run twice in quick succession. The interval between the end of the first "AUTOCAL" function and the start of the second "AUTOCAL" function must be shorter than 2.0s. The second "AUTOCAL" function only takes around 2.0s and includes the "AUTOCOMP" function.

If the interval between the two "AUTOCAL" functions is longer than 2.0s, "AUTOCAL" is run without "AUTOCOMP" the second time.

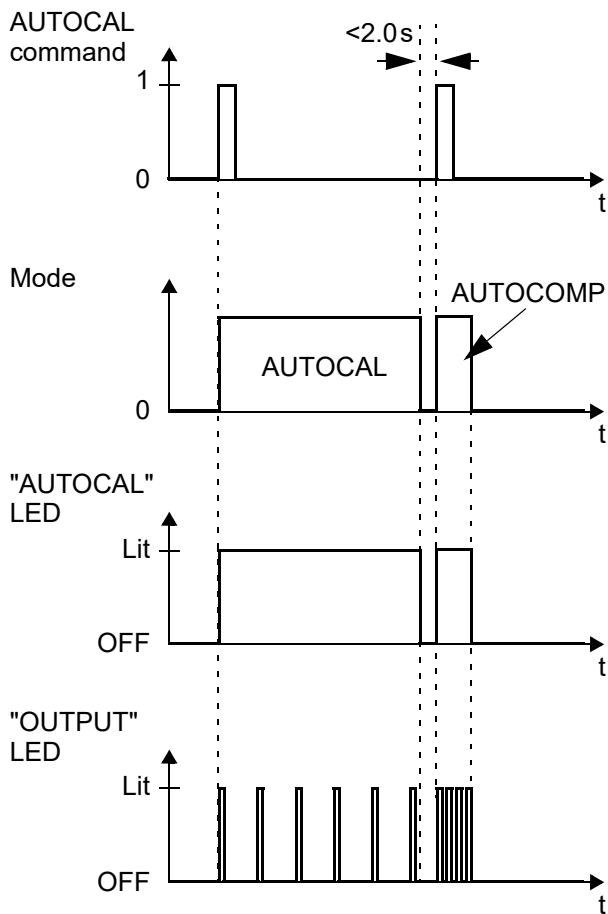

The "OUTPUT" LED blinks repeatedly while the "AUTOCOMP" function is running and the actual value output (terminals 17+18) is set to 0...3°C (corresponds to approx. 0VDC).

3. "AUTO"

(as of software revision 102)

This setting causes the "AUTOCOMP" function to be automatically started as soon as "AUTOCAL" has been successfully executed.

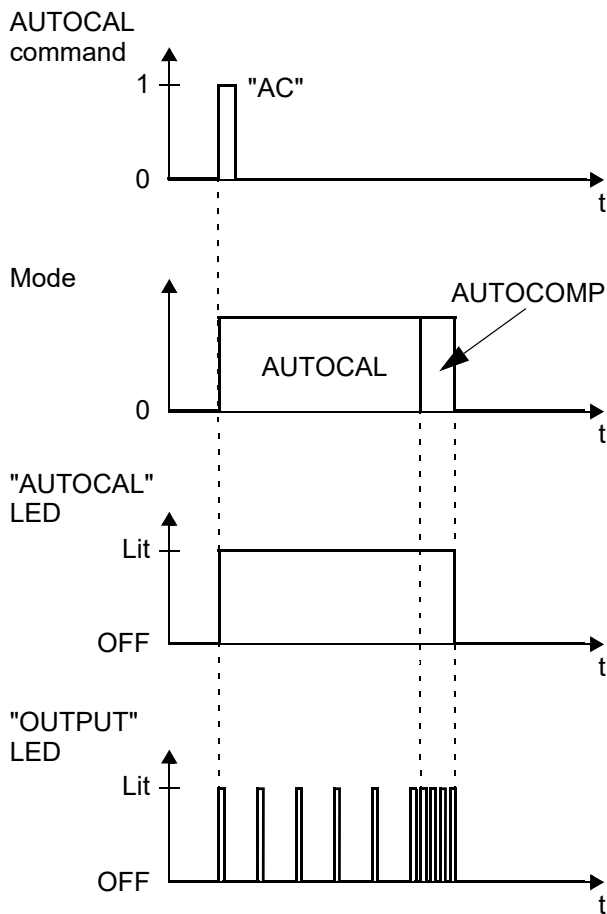

The "OUTPUT" LED blinks repeatedly while the "AUTOCOMP" function is running and the actual value output (terminals 17+18) is set to 0...3°C (corresponds to approx. 0VDC).

 The "AUTOCOMP" function must be activated either in the ROPEX visualization software (↪ section 10.12 "Diagnostic interface / visualization software (as of February 2007)" on page 50) or via the CAN interface (CAN message address 13) (default setting: AUTOCOMP off).

10.9 Temperature monitoring / "temperature OK" bit (as of February 2007)

In control mode (START is active), the RES-409 checks whether the ACTUAL temperature is within a settable tolerance band ("OK" window) either side of the SET temperature.

The "Temperature OK" function is specified in CAN message address 9. The lower and upper tolerance band limits ($\Delta\vartheta$) can be varied between 3 and 99°C (up to January 2007: 3...20°C) with CAN message address 7. The upper and lower tolerance band limits can also be set independently of one another on controllers manufactured as of February 2007 (CAN message addresses D and E).

The following settings are possible:

1. **"Off"**

"Temperature OK" bit has no function.

2. **"Active if Tact = Tset" (factory setting)**

The "Temperature OK" bit (bit 3) in the controller status (↪ section 10.4.1 "Controller status" on page 39) has the value "1" if the actual value is inside the specified temperature tolerance band (CAN message address 7 or addresses D and E). If the actual temperature is outside the tolerance band, the "Temperature OK" bit has the value "0" (see graph below).

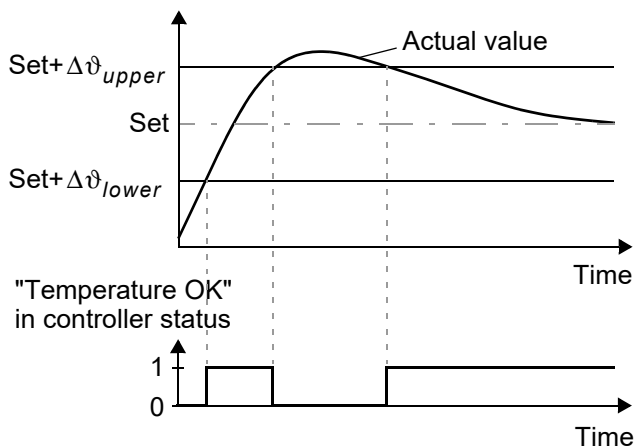

3. "Active if Tact = Tset" with latch function

The "Temperature OK" bit (bit 3) in the controller status (Ψ section 10.4.1 "Controller status" on page 39) has the value "1" if the actual value is inside the specified temperature tolerance band (CAN message address 7 or addresses D and E). If the actual temperature leaves the tolerance band even once while a "START" command - or a "START" signal - is active, the value of the "Temperature OK" bit changes to "0". This value applies until the next START command is received (or the next start signal is activated). The state of the "Temperature OK" bit can thus also be interrogated by the higher-level PLC after a heatsealing process (latch function, see graph below).

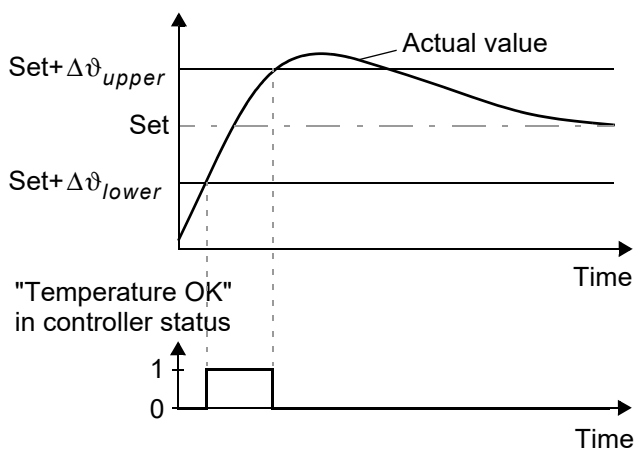

10.10 Temperature diagnosis (as of February 2007)

An additional temperature diagnosis can be activated in the ROPEX visualization software (Ψ section 10.12 "Diagnostic interface / visualization software (as of February 2007)" on page 50). The RES-409 checks whether the ACTUAL temperature is within a settable tolerance band ("OK" window) either side of the SET temperature. The lower ($\Delta\vartheta_{lowern}$) and upper ($\Delta\vartheta_{upper}$) tolerance band limits are configured in the factory to -10K and +10K. These values can be set independently of one another in the ROPEX visualization software.

If the ACTUAL temperature is inside the specified tolerance band when a START command is sent via the CAN interface - or a 24VDC signal (START 0 or START 1) is activated - the temperature diagnosis is also activated. If the ACTUAL temperature leaves the tolerance band, the corresponding error code (307 or 308) is indicated and the fault output is switched (Ψ section 10.16 "Error messages" on page 52).

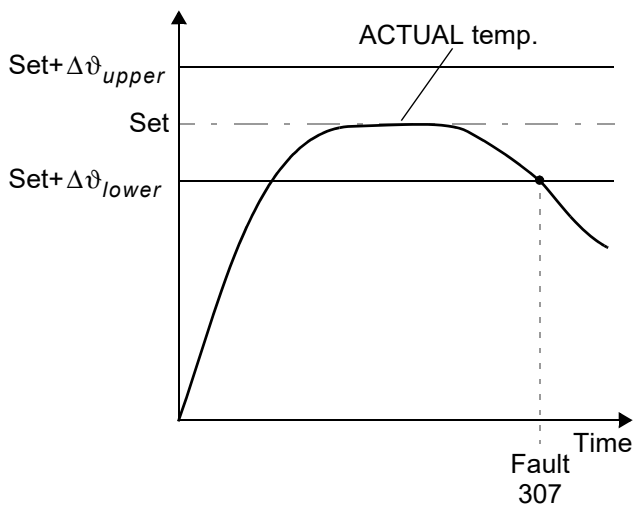

If the temperature diagnosis is not activated by the time the "START" signal is deactivated (i.e. if the ACTUAL temperature does not exceed the upper or lower tolerance band limit), the corresponding error code (309 or 310) is indicated and the fault relay is switched.

An additional delay time (0..9.9s) can be set via the CAN interface (CAN message address 10) or in the ROPEX visualization software. The first time the lower tolerance band limit is exceeded, the temperature diagnosis is not activated until the parameterized delay time has elapsed. The temperature diagnosis function can thus be selectively deactivated, e.g. if the temperature drops temporarily because the sealing jaws are closed.

⚠ The values that can be set in the ROPEX visualization software for the upper and lower tolerance band are identical to those for the "Temperature OK" bit. These values are transferred with CAN message address 7 (or addresses D and E).

10.11 Heatup timeout (as of February 2007)

An additional heatup timeout can be activated either in the ROPEX visualization software (↪ section 10.12 "Diagnostic interface / visualization software (as of February 2007)" on page 50) or via the CAN interface (CAN message address 11). This timeout starts as soon as any START command is received via the CAN interface (or the 24VDC START 0 signal is activated).

The RES-409 then monitors the time required for the ACTUAL temperature to reach 95% of the SET temperature. If this time is longer than the parameterized time, the corresponding error code (304) is indicated and the fault relay is switched (↪ section 10.16 "Error messages" on page 52).

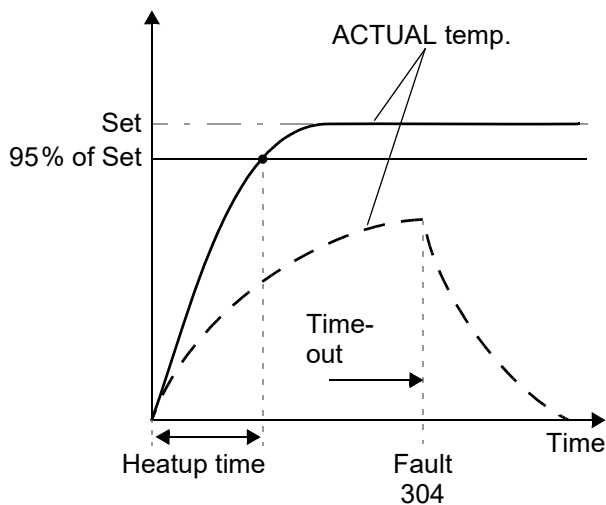

! The heatup timeout cannot be started with the 24VDC START 1 signal. This signal has no function here.

! The heatup timeout must be activated either in the ROPEX visualization software (↪ section 10.12 "Diagnostic interface / visualization software (as of February 2007)" on page 50) or via the CAN interface (CAN message address 11) (default setting: heatup timeout off).

10.12 Diagnostic interface / visualization software (as of February 2007)

An interface with a 6-pole Western socket is provided for system diagnostics and process visualization. This interface allows a data connection to be set up to the ROPEX visualization software using the ROPEX CI-USB-1 communication interface.

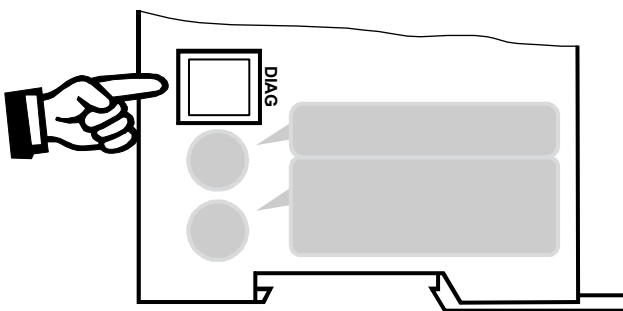

! Only a ROPEX communication interface is allowed to be connected to the diagnostic interface. Connecting another device (e.g. a telephone cable) could result in malfunctions or damage to the controller.

The ROPEX visualization software is described in a separate document.

10.13 Booster connection

All controllers manufactured up to January 2007 only have an optional connection for an external switching amplifier (booster) (↪ section 5.2 "Modifications (MODs)" on page 10). Modification 26 (MOD 26) must be installed in the controller for this purpose.

A booster connection is provided as standard on all RES-409 controllers manufactured as of February 2007.

This connection (at terminals 15+16) is necessary for high primary currents (continuous current > 5A, pulsed current > 25A). The switching amplifier should be wired as described in section 8.7 "Wiring diagram with booster connection (MOD 26)" on page 21.

10.14 Undervoltage detection (as of February 2007)

Trouble-free operation of the temperature controller is guaranteed within the line voltage tolerance range specified in section 6 "Technical data" on page 11.

If the line voltage drops below the lower limit of the permissible range, the controller is switched to standby mode.

This is also indicated in the controller status, bit no. 14 (↪ section 10.4.1 "Controller status" on page 39).

Normal operation is automatically resumed when the input voltage returns to the specified tolerance range.

Standby mode is indicated by 0...3°C (corresponds to approx. 0V) at the analog output.

 **Trouble-free operation of the controller is only guaranteed within the specified input voltage tolerance range. An external voltage monitor must be connected to prevent defective heatseals as a result of low line voltage.**

10.15 System monitoring / fault output

To increase operating reliability and prevent faulty heatsealing, the controller incorporates special hardware and software features that facilitate selective fault messages and diagnosis. Both the external wiring and the internal system are monitored.

These features crucially support the system owner in localizing the cause of an abnormal operating state.

System faults are reported or differentiated by means of the following elements.

A.) Red "FAULT" LED on the controller lights up with three states:

1. Blinks fast (4Hz)

The "AUTOCAL" function must be run (error codes 8+9; as of February 2007 also: 104...106, 211, 302, 303).

2. Blinks slowly (1Hz)

The system configuration is incorrect and the zero calibration (AUTOCAL function) was therefore unsuccessful (↪ section 9.2 "Controller configuration" on page 22). This corresponds to error codes 10...12 (as of February 2007 also: 111...114).

1. Lit continuously:

This indicates a fault that prevents the controller from being started up (error codes 1...7; as of February 2007 also: 101...103, 107, 108, 201...203, 307, 308, 801, 9xx).

Also in instances 1 and 2 if a "START" command is simultaneously sent.

As a rule, this refers to an external wiring fault.

B.) Fault relay (relay contact terminals 12+13+14):

The fault relay is set in the factory as follows:

- **NOT ACTIVE** in operating states A.1 and A.2, but active if a "START" signal is activated in one of these states.
- **ACTIVE** in operating state A.3.

If the fault relay is configured differently from the factory setting (↪ section 9.2.3 "Configuration of the fault relay" on page 24), these states are inverted.

C.) Error code output by means of the CAN protocol

If an error occurs, the fault bit is set in the controller status (bit 4) (↪ section 10.4.1 "Controller status" on page 39) and in the acknowledgment message (bit 14) (↪ section 10.4.2 "Acknowledgment message" on page 40). The error message appears at bit positions 8...11 in the controller status.

D.) Error code output by means of the 0 to 10V actual value output (terminals 17+18):

Since the temperature no longer needs to be indicated if the controller is faulty, the actual value output is used to display error codes in the event of a fault.

13 voltage levels (up to January 2007: 12 voltage levels) are provided for this purpose in the 0...10VDC range, each of which is assigned an error code (↪ section 10.16 "Error messages" on page 52).

If a state that requires "AUTOCAL" occurs – or if the controller configuration is incorrect – (error codes 8...12; as of February 2007 also: 104...106, 111...114, 211, 302, 303), the actual value output jumps back and forth at 1 Hz between the voltage value corresponding to this error and the end of the scale (10VDC, i.e. 300 °C or 500 °C). If a "START" command is sent in one of these states (or a "START" signal is activated), the voltage value no longer changes.



An error message can only be reset by sending a "RESET" command or by switching the controller off and then on again.



Invalid error messages may appear when the controller is switched off owing to the undefined operating state. This must be taken into account when they are evaluated by the higher-level controller (e.g. a PLC) in order to avoid false alarms.

10.16 Error messages

A detailed fault diagnosis can be carried out using the CAN protocol. A two-digit error code (4-bit) can be queried for this purpose via CAN message address 4, value 4 (↪ section 10.4.1 "Controller status" on page 39). All controllers manufactured as of February 2007 support three-digit error codes (10-bit) as an additional option. This can be queried with CAN message address 4, value 13 (↪ section 10.4.3 "Fault / AUTOCAL status (as of February 2007)" on page 41).

The error codes provide information about the exact cause of the fault. A voltage corresponding to the error code is additionally generated at the actual value output.

The table below shows how the analog voltage values at the actual value output are assigned to the faults that have occurred. It also describes each fault and the required corrective action.

The error messages are listed in two separate tables for controllers "up to January 2007" and "as of February 2007". The block diagram in section 10.17 "Fault areas and causes" on page 57 permits each fault to be cleared quickly and efficiently.

13 voltage levels for fault diagnostics appear at the actual value output of all controllers manufactured as of February 2007. The error messages are differentiated even more finely internally. The error codes described below can also be displayed via the CAN interface (CAN message address 4, value 13) or in the ROPEX visualization software (↪ section 10.12 "Diagnostic interface / visualization software (as of February 2007)" on page 50 to facilitate troubleshooting).



If the actual value output is evaluated in order to identify an error message – in the higher-level controller, for instance – the tolerance window must be adjusted to prevent it from being incorrectly interpreted. Please note the tolerances of the actual value output (↪ section 6 "Technical data" on page 11).

Error messages as of February 2007									
Part 1 of 3:			Error messages as of February 2007						
Error code	Act. value output; Voltage [V]	Temp. 300 °C [°C]	Temp. 500 °C [°C]	ALARM LED	STATUS of alarm relay (factory set.)	Cause	Action if machine started for first time	Action if machine already operating, HS band not chang.	
1 (101)	0.66	20	33	Lit continuously	Energized	I _R signal missing	Fault area ①	Fault area ①	
2 (102)	1.33	40	66			U _R signal missing	Fault area ③	Fault area ③	
3 (103)	2.00	60	100			U _R and I _R signals missing	Fault area ②	Fault area ②⑨	
(107) (108)						Temperature step, down Temperature step, up	Fault area ④⑤⑥ (loose contact)	Fault area ④⑤⑥ (loose contact)	
4 (307) (308) (309) (310)	2.66	80	133			Temperature too low/high (☛ section 10.10)			
5 (201) (202) (203)	3.33	100	166			Frequency fluctuation, inadmissible line frequency	Check power supply	Check power supply	
6 (304)	4.00	120	200			Heatup time too long (☛ section 10.11)	Run RESET	Run RESET	
(901) (913) (914) (915) (916)	4.66	140	233			Int. faut, contr. defective Triac defective Int. faut, contr. defective Int. faut, contr. defective Int. faut, contr. defective	Replace controller Replace controller Replace controller Replace controller Replace controller	Replace controller Replace controller Replace controller Replace controller Replace controller	
(917) (918)						Plug-in jumper for alarm output wrong	Check plug-in jumper	Check plug-in jumper	

Part 2 of 3: Error messages as of February 2007										
NOTE: The specified error messages are initially output as warnings (actual value output jumps back and forth between two values; alarm LED blinks; alarm relay is de-energized). When the "START" signal is activated, the warning changes to a fault (actual value output no longer jumps back and forth, see bold italic values ; alarm LED lit continuously; alarm relay is energized).										
Error code	Act. value output; Volt. [V]	Temp. 300 °C [°C]	Temp. 500 °C [°C]	ALARM LED	STATUS of alarm relay (factory set.)	Cause	Action if machine started for first time	Action if machine already operating, HS band not chang.		
8	(104)				Warning: De-Energized Fault: Energized (voltage value at actual value output then no longer changes)	I _R signals incorrect, incorrect specification of impulse-transformer	Run AUTOCAL , Check specification of transformer, Fault area ⑦ ⑧	Fault area ④ ⑤ ⑥ (loose contact)		
	(105)					U _R signals incorrect, incorrect specification of impulse-transformer				
	(106)	↔ 5.33 ↗ ↘ 10 ↗	↔ 160 ↗ ↘ 300 ↗	↔ 266 ↗ ↘ 500 ↗		U _R and/or I _R signals incorrect, incorrect specification of impulse-transformer				
	(302)					Temperature too low, AUTOCAL wasn't performed, loose contact, ambient temp. fluctuates			Run AUTOCAL and/or fault area ④ ⑤ ⑥ (loose contact)	
	(303)					temperature too high, AUTOCAL wasn't performed, loose contact, ambient temp. fluctuates				
9	↔ 6.00 ↗ ↘ 10 ↗	↔ 180 ↗ ↘ 300 ↗	↔ 300 ↗ ↘ 500 ↗		Data error	Run AUTOCAL	---			

Part 3 of 3: Error messages as of February 2007

NOTE: The specified error messages are initially output as warnings (actual value output jumps back and forth between two values; alarm LED blinks; alarm relay is de-energized). When the "START" signal is activated, the warning changes to a fault (actual value output no longer jumps back and forth, see **bold italic values**; alarm LED lit continuously; alarm relay is energized).

Error code	Act. value output; Volt. [V]	Temp. 300 °C [°C]	Temp. 500 °C [°C]	ALARM LED	STATUS of alarm relay (factory set.)	Cause	Action if machine started for first time	Action if machine already operating, HS band not chang.			
10 (111)	↔ 6.66 ↗ ↘ 10 ↗	↔ 200 ↗ ↘ 300 ↗	↔ 333 ↗ ↘ 500 ↗	Warning: Blinks slowly (1Hz)	Warning: De-Energized	I _R signal incorrect, calibration not possible	Fault area ⑧, check configuration	---			
11 (112)	↔ 7.33 ↗ ↘ 10 ↗	↔ 220 ↗ ↘ 300 ↗	↔ 366 ↗ ↘ 500 ↗						U _R signal incorrect, calibration not possible	Fault area ⑦, check configuration	---
12 (113)	↔ 8.00 ↗ ↘ 10 ↗	↔ 240 ↗ ↘ 300 ↗	↔ 400 ↗ ↘ 500 ↗						U _R and I _R signals incorrect, calibration not possible	Fault area ⑦⑧, check configuration	---
(114)				Fault: Lit continuously	Fault: Energized (voltage value at actual value output then no longer changes)	Temperature fluctuates, calibration not possible					
13 (115)	↔ 8.66 ↗ ↘ 10 ↗	↔ 260 ↗ ↘ 300 ↗	↔ 433 ↗ ↘ 500 ↗			Ext. calibration temperature too high, calibration not possible					
(116)				Ext. calibration temperature fluctuates calibration not possible							

Error messages up to January 2007											
Error code	Act. value output ; Voltage [V]	Temp. 300 °C [°C]	Temp. 500 °C [°C]	ALARM LED	STATUS of alarm relay (factory set.)	Cause	Action if machine started for first time	Action if machine already operating, HS-band not chang.			
1	0.66	20	33	Lit Continuously	Energized	I _R signal missing	Fault area ①	Fault area ①			
2	1.33	40	66			U _R signal missing	Fault area ③	Fault area ③			
3	2.00	60	100			U _R and I _R signals missing	Fault area ②	Fault areas ②⑨			
4	2.66	80	133			Temperature step	Fault areas ④⑤⑥ (loose contact)	Fault areas ④⑤⑥ (loose contact)			
5	3.33	100	166			Frequency fluctuation, inadmissible line frequency	Check power supply	Check power supply			
6	4.00	120	200			Internal fault	Run RESET	Run RESET			
7	4.66	140	233			Internal fault, controller defective	Replace controller	Replace controller			
8	↔ 5.33 ↕ ↔ 10 ↕	↔ 160 ↕ ↔ 300 ↕	↔ 266 ↕ ↔ 500 ↕			Blinks fast (4Hz)	U _R and/or I _R signal incorrect	Run AUTOCAL	Fault areas ④⑤⑥		
9	↔ 6.00 ↕ ↔ 10 ↕	↔ 180 ↕ ↔ 300 ↕	↔ 300 ↕ ↔ 500 ↕			Blinks slowly (1Hz)	Data error	Run AUTOCAL	---		
10	↔ 6.66 ↕ ↔ 10 ↕	↔ 200 ↕ ↔ 300 ↕	↔ 333 ↕ ↔ 500 ↕				I _R signal incorrect, calibration not possible	Fault area ⑧, check configuration	---		
11	↔ 7.33 ↕ ↔ 10 ↕	↔ 220 ↕ ↔ 300 ↕	↔ 365 ↕ ↔ 500 ↕				U _R signal incorrect, calibration not possible	Fault area ⑦, check configuration	---		
12	↔ 8.00 ↕ ↔ 10 ↕	↔ 240 ↕ ↔ 300 ↕	↔ 400 ↕ ↔ 500 ↕				U _R and I _R signals incorrect, calibration not possible	Fault areas ⑦⑧, check configuration	---		

10.17 Fault areas and causes

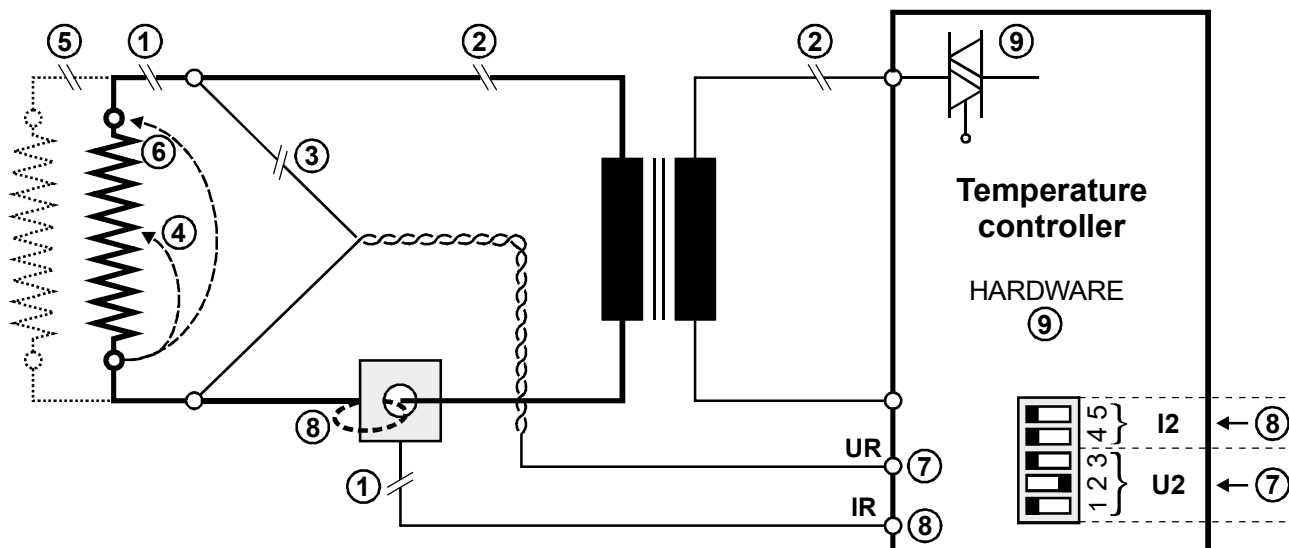



The table below explains the possible fault causes.



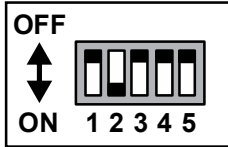
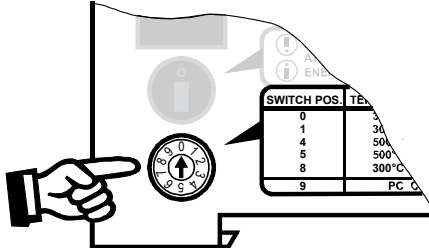
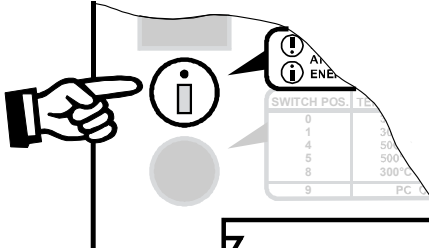

Fault area	Explanation	Possible causes
①	Load circuit interrupted after U_R pickoff point	- Wire break, heatsealing band break - Contact to heatsealing band is defective
	PEX-W2/-W3 current transformer signal interrupted	- I_R measuring wires from current transformer interrupted
②	Primary circuit interrupted	- Wire break, triac in controller defective - Primary winding of impulse transformer interrupted
	Secondary circuit interrupted before U_R -pickoff point	- Wire break - Secondary winding of impulse transformer interrupted
③	U_R signal missing	- Measuring wires interrupted
④	Partial short-circuit (ΔR)	- Heatsealing band partially bypassed by conducting part (clamp, opposite heatsealing bar etc.)
⑤	Parallel circuit interrupted	- Wire break, heatsealing band break - Contacting to heatsealing band defective
⑥	Total short-circuit	- Heatsealing band installed incorrectly, insulation at heatsealing bar ends missing or incorrectly installed - Conducting part bypasses heatsealing band completely
⑦	U_R signal incorrect	- Up to Jan. 2007: DIP switches 1 - 3 configured incorrectly (U_2 range) - As of Feb. 2007: U_2 outside permissible range from 0.4...120VAC

Fault area	Explanation	Possible causes
⑧	I_R signal incorrect	- Up to Jan. 2007: DIP switches 4 + 5 configured incorrectly (I_2 range) - As of Feb. 2007: I_2 outside permissible range from 30...500A
	Turns through PEX-W2/-W3 current transformer incorrect	- Check number of turns (two or more turns required for currents < 30A)
⑨	Internal controller fault	- Hardware fault (replace controller) - Plug-in jumper for alarm output not connected or incorrectly connected

11 Factory settings

The RESISTRON® temperature controller RES-409 is configured in the factory as follows:

<p><u>DIP switches</u> for secondary voltage U_2 and current I_2 (up to January 2007)</p>		<p>$U_2 = 6...60VAC$ $I_2 = 30...100A$</p> <p>DIP switches: 2 ON 1, 3, 4, 5 OFF</p> <p>These switches are automatically set by the AUTORANGE function on all controllers manufactured as of February 2007.</p>
<p><u>Rotary coding switch</u> for heatsealing band alloy and temperature range (as of February 2007)</p>		<p>Heatsealing band alloy: Alloy A20 Temperature range: 300 °C</p> <p>Rotary coding switch: "0" position</p>
<p><u>Plug-in jumper</u> for alarm relay</p>		<p>Alarm relay is energized at alarm</p>
<p><u>Automatische Phasenkorrektur</u> (AUTOCOMP) [X]</p>		<p>AUTOCOMP: AUS</p>

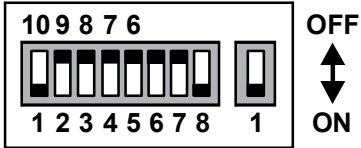





<p><u>Measuring impulse length</u></p> <p>[X]</p>		<p>Measuring impulse length: 1.7ms</p>
<p><u>Temperature diagnosis</u></p> <p>[X]</p>		<p>Temperature diagnosis: OFF</p>
<p><u>Heatup timeout</u></p> <p>[X]</p>		<p>Heatup timeout: OFF</p>
<p><u>Output 1</u></p> <p>[X]</p>		<p>„Temperature OK“-Bit: active if $T_{act} = T_{set}$</p>
<p><u>Hold mode</u></p> <p>[X]</p>		<p>Hold mode: OFF</p>
<p><u>DIP switch for identifier and baudrate</u></p>		<p><u>As of February 2007:</u> Identifier = 0 Baudrate = AutoBaud Termination = ON</p> <p><u>Up to January 2007:</u> Identifier = 1024_{dez} Baudrate = 205kBaud Termination = ON</p>

[X] As of February 2007:
With ROPEX visualization software or via CAN-Bus interface only.

12 Maintenance

The controller requires no special maintenance. Regular inspection and/or tightening of the terminals – including the terminals for the winding connections on the impulse transformer – is recommended. Dust deposits on the controller can be removed with dry compressed air.

13 How to order

	<p>Contr. RES - 409 / . . . VAC</p> <ul style="list-style-type: none"> → 115: Power supply 115VAC, Art. No. 740901 → 230: Power supply 230VAC, Art. No. 740902 → 400: Power supply 400VAC, Art. No. 740903 <p>Scope of supply: Controller includes connector plug-in parts (without current transformer)</p> <p>Modification MOD . . (optional, if required)</p> <ul style="list-style-type: none"> → e.g. 01: MOD 01, Art. No. 800001 (Amplifier for low voltage) <p>Please indicate the article numbers of the controller and the required modifications (optional) in all orders, e.g. RES-409/400VAC + MOD 01 (controller for 400VAC power supply with amplifier for low voltage) Art. No. 740903 + 800001 must be ordered</p>
	<p>Current transformer PEX-W3 Art. No. 885105</p>
	<p>Line filter LF- . . 480</p> <ul style="list-style-type: none"> → 06: Continuous current 6A, 480VAC, Art. No. 885500 → 35: Continuous current 35A, 480VAC, Art. No. 885506
	<p>Impulse transformer</p> <p>See ROPEX Application Report for design and ordering information</p>
	<p>CAN-Bus connection cable, 3 pin, length 2m Art. No. 886487</p>
	<p>Communication interface CI-USB-1 Art. No. 885650</p>
	<p>Temp. meter ATR- .</p> <ul style="list-style-type: none"> → 3: 300°C range, Art. No. 882130 → 5: 500°C range, Art. No. 882150



Booster B- . . . 400

→ **075:** Max. pulse load 75A, 400VAC, Art. No. 885301
100: Max. pulse load 100A, 400VAC, Art. No. 885304

14 Index

A

ACTUAL temperature 38
Actual value output 42
Alarm relay 12
Alloy 23, 29, 37
Ambient temperature 13
Analog temperature meter 9
Application 7
Application Report 15, 18, 22
AutoBaud 25
AUTOCAL 8, 29, 36
AUTOCOMP 45
Automatic baud rate detection 25
Automatic phase compensation 45
Automatic zero calibration 8, 29
AUTOTUNE 8

B

Booster 10, 21, 61
Booster connection 50
Burning in heatsealing band 27

C

CAN messages
 Receiving 32
 Sending 38
CAN protocol 31
CAN-Bus interface 11
Circuit-breaker 17
CI-USB-1 9, 50, 60
Communication interface 9, 50, 60
Controller status 39
Current transformer 10, 18, 60

D

Degree of protection 13
Diagnostic interface 50
Digital temperature meter 9
DIP switches 22
Disposal 5

E

Error messages 52
External switching amplifier 10, 21

F

Factory settings 58
Fault areas 57
Fault diagnosis 8
Fault output 51
Fault relay 24
Fuse 17

H

Heatsealing band alloy 37
Heatsealing band type 12
Heatup timeout 49
Hold mode 43

I

Impulse heatsealing method 7
Impulse transformer 9, 17, 60
Installation 13, 14
Installation procedure 14
Installation regulations 15

L

Line filter 4, 9, 17, 18, 60
Line frequency 8, 11
Line voltage 11

M

Maintenance 4, 59
Measurement cable 10
Measuring impulse length 45
Modifications (MODs) 10, 60
MODs 10, 60
Monitoring current transformer 10

O

Over-current protection 17
Overheating of heatsealing band 8

P

PEX-W3 60
PEX-W4/-W5 4, 18
Phase compensation 45
Power dissipation 12
Power supply 17, 60
Principle of operation 7

R

Reasons for locked "AUTOCAL" function 36
Replacing the heatsealing band 28, 29
RESET command 37

S

Secondary current I_2 22
Secondary voltage U_2 22
Set point selection 34
Standby mode 51
START signal 34
START/STOP command 34
System diagnostics 50
System monitoring 51

T

TCR 3, 27
Temperature coefficient 3, 27
Temperature control 7
Temperature meter 9, 42, 43, 60
Temperature monitoring 47
Temperature OK bit 47
Temperature range 12, 23, 37
Temperature reached bit 40
Transformer 4, 9, 17, 60
Transportation 4

Type of construction 11

U

Undervoltage detection 51

V

Visualization software 50

W

Wiring 15, 17